

Vianet Online Backup 5.5.x User's Guide

Notes:

Not all features described in this User's Guide are available in the Backup Manager Lite Client. Please [contact support](#) should you need to switch to the full featured Backup Manager Client.

Access to [Web Features](#) is available [upon request](#).

Trademarks

Microsoft, Windows, Microsoft Exchange Server and Microsoft SQL Server are registered trademarks of Microsoft Corporation.
Sun, Solaris, SPARC, Java and Java Runtime Environment are registered trademarks of Sun Microsystems Inc.
Oracle, Oracle 8i, Oracle 9i are registered trademarks of Oracle Corporation.
Lotus, Domino, Notes are registered trademark of IBM Corporation.
Red Hat is registered trademark of Red Hat, Inc.
Linux is registered trademark of Linus Torvalds.
Apple and Mac OS X are registered trademarks of Apple Computer, Inc.

All other product names are registered trademarks of their respective owners.

Table of Content

1	Overview	4
1.1	Benefits	4
1.2	Features	4
1.3	Security	5
1.4	System Requirements	6
2	Installing Vianet Backup Manager	7
2.1	Installing Vianet Backup Manager for Windows	7
2.2	Installing Vianet Backup Manager for Mac OS X	8
2.3	Installing Vianet Backup Manager for Linux/Unix	9
2.4	Installing Vianet Backup Manager for Netware	13
3	Uninstalling Vianet Backup Manager	14
3.1	Uninstalling Vianet Backup Manager for Windows	14
3.2	Uninstalling Vianet Backup Manager for Mac OS X	14
3.3	Uninstalling Vianet Backup Manager for Linux/Unix	14
3.4	Uninstalling Vianet Backup Manager for Netware	14
4	Using Vianet Backup Manager	16
4.1	System Tray Launcher (Windows Only)	16
4.2	Logon Dialog	17
4.3	Language Selection	17
4.4	Main Window	17
4.6	Backup Logs	17
5	Setting Up Backup Sets	19
5.1	Backup Set Type	19
5.2	Backup Source	20
5.3	Backup Schedule	22
5.4	Continuous Data Protection (CDP)	22
5.5	Encryption	24
5.6	Mapped Network Drive	24
5.7	Backup Filter	26
5.8	Pre/Post-Backup Command	29
5.9	Temporary directory	30
5.10	Transfer Block Size	30
5.11	Follow Symbolic Link (Linux/Unix/Mac only)	31
5.12	Microsoft's Volume Shadow Copy Service (VSS)	31
5.13	Retention Policy	31
5.14	Extra Backup (Off-Line backup, Logout Reminder)	34
5.15	In-File Delta	34
5.16	Local Copy	34
5.17	Using One Backup Account for Multiple Computers	37
6	Backing Up Files	38
6.1	How files are backed up	38
6.2	Backup files directly to the backup server	39
6.3	Backup files to removable hard disk (seed loading)	41
7	Restoring Files	43
7.1	Restore backup files directly from backup server	43
7.2	Restore backup files from removable hard disk	45
7.3	IP addresses Restriction for Online Restore	47
8	In-File Delta Technology	48
8.1	Overview	48
8.2	Block Size	50
8.3	Minimum File Size	50
8.4	Uploading full file again	50
8.5	Advanced In-file delta type	51
9	Backup/Restore Oracle 8i/9i/10g	52
9.1	Requirements	52
9.2	Overview	53
9.3	How to backup an Oracle Database (Physical Backup)	54

9.4	How to restore an Oracle Database.....	57
9.5	How to restore a single tablespace.....	63
9.6	Export and Import a Database (Logical Backup).....	66
10	Backup/Restore Microsoft SQL Server 7.0 / 2000 / 2005	68
10.1	Requirements	68
10.2	Overview	68
10.3	How to backup Microsoft SQL Server database(s).....	68
10.4	How to restore Microsoft SQL Server database(s)	71
11	Backup/Restore Lotus Domino / Notes.....	77
11.1	Requirements	77
11.2	Overview	78
11.3	How to backup Lotus Domino / Notes database(s) / file(s) on Windows	79
11.4	How to restore Lotus Domino / Notes database(s) / file(s) on Windows.....	81
11.5	How to backup Lotus Domino / Notes database(s) / file(s) on Linux.....	83
11.6	How to restore Lotus Domino / Notes database(s) / file(s) on Linux	86
12	Backup/Restore Microsoft Exchange Server	88
12.1	Requirements	88
12.2	Overview	88
12.3	How to backup Microsoft Exchange Server	89
12.4	How to restore Microsoft Exchange Server.....	91
13	Backup/Restore Windows System State	95
13.1	Requirements	95
13.2	Overview	95
13.3	How to backup Windows System State	95
13.4	How to restore Windows System State.....	98
14	Backup/Restore Individual Brick Level Backup for Microsoft Exchange Server.....	99
14.1	Requirements	99
14.2	Overview	99
14.3	Granting Privileges	99
14.4	How to backup Individual Brick Level Backup.....	100
14.5	How to restore Individual Brick Level Backup	104
15	Backup/Restore MySQL Server.....	106
15.1	Requirements	106
15.2	Overview	106
15.3	How to backup MySQL server on Windows	106
15.4	How to backup MySQL server on Linux (command line mode).....	109
15.5	How to restore MySQL server.....	110
16	Email Reporting	111
17	Web Features.....	112
17.1	Restore/Delete/Undelete Backup Files	112
17.2	Review Backup Jobs.....	112
17.3	Review Storage Statistics	114

1 Overview

1.1 Benefits

- Easy Backup of
 1. Microsoft Exchange Server 2000 / 2003 / 2007
 2. Microsoft SQL Server 7.0 / 2000 / 2005
 3. Lotus Domino/Notes 5.0 or above
 4. Oracle 8i or above
 5. MySQL 3.2.4 or above
 6. Windows System State
 7. Outlook and Outlook Express (i.e. *.pst, *.dbx and *.wab)
 8. Important personal settings, e.g. Desktop, Favorite, My Documents and History etc
 9. Other common files (e.g. *.doc, *.xls)
- Support backing up only changes within a file (using in-file delta technology)
- Support backing up of open files on Windows XP/2003/Vista (Volume Shadow Copy)
- Support backing up of Windows NTFS access privileges, Linux access privileges and modes, Mac OS X metadata and resource forks
- Easy to use, deploy and maintain



1.2 Features

- Continuous data protection - start backup whenever a file is being modified
- "Backup and Sleep (Hibernate)" and "Backup and standby"
- Allow backup schedule to run every X minutes
- Full support of Microsoft Exchange individual email, contacts, calendars, tasks etc.
- Choose whether to restore "file permissions" during restore.
- For "Local Copy" backup, ability to choose whether to perform a local copy backup only and skip the offsite backup.
- Lotus Notes/Domino agent for Linux.
- Auto Upgrade Agent to automatically upgrade the client software.
- User configurable incremental / differential in-file delta backup mode (i.e. backing up only changes within a file since the last incremental or full backup according to each user's preference).
- Allow in-file delta backup mode to be overridden by each user individually according to backup time (e.g. enforcing full (or incremental or differential) backup of all files every Sunday or the 1st day of every month).
- Volume Shadow Copy backup (i.e. backing up files even when they are exclusively open, e.g. Outlook.pst).
- In-File Delta backup (i.e. backing up only changes within files).
- Off-line backup mode and logout backup reminder.
- Customizable backup schedule allows backups to be scheduled at any time.
- Compress and encrypt data automatically before sending them to the server (server stores only encrypted data).
- Increment backup strategy ensures that only new or updated files are sent to the backup server.
- Support both full backup (database backup) and incremental backup (transaction log backup) for Microsoft SQL Server 7.0/2000, Microsoft Exchange Server 2000/2003, Lotus Domino/Notes 5.0 and Oracle 8i or above.
- Can integrate with external "Open File Manager" to provide open file backup support to all open files.
- Access backup data anytime, anywhere by using a web browser.
- Comprehensive backup report lists all files backed up. Backup report delivered automatically via email.
- Backup data are CRC validated before they are stored on server.
- Fully user customizable data retention policy allows users to have access to deleted files using the least possible storage space on the backup server.
- Can select source backup files easily by using a backup filter, e.g. selecting all *.doc and *.xls in your computer in a single operation.
- Run any custom OS commands before/after a backup job.
- Run on Windows, Mac OS X, Linux, NetWare, UNIX and all other platforms supporting a Java2 Runtime Environment.
- Periodic backup files validation on backup server ensures backup files are 100% valid and fully restorable when needed.

1.3 Security

- 128-bit point-to-point SSL communication between server and client
- Support HTTP/HTTPS Proxy and Socks v4/v5 firewall
- Data are 128-bit/256-bit encrypted when stored on the backup server
- An random initializing vector, salt and iteration count will be generated by the software automatically for each file when encrypting your data
- Each backup user can restrict online access to his files to his pre-defined list of IP addresses [upon request](#)

1.4 System Requirements

Client-side applications			
	Supported Platforms	Application Compatibilities	Hardware Requirements
Vianet Backup Manager 	<ul style="list-style-type: none"> Windows 2000 / XP / 2003 / Vista Linux kernel 2.4 or above NetWare 5.1 or above Solaris 2.x or above AIX HP-UX FreeBSD Mac OS X 10.3+ All other operating systems that supports Java2 Runtime Environment 1.4.0 or above 	<ul style="list-style-type: none"> Microsoft Exchange Server 2000 / 2003 / 2007 Microsoft SQL Server 7.0 / 2000 / 2005 Lotus Domino / Lotus Notes 5.0 or above Oracle 8i or above MySQL 3.2.4 or above Outlook / Outlook Express i.e. *.pst, *.dbx and *.wab Other common files e.g. *.doc, *.xls Also supports backing up of: <ul style="list-style-type: none"> Windows System State (all platforms except Vista) Windows NTFS access privileges Linux access privileges and modes Mac OS X metadata and resource forks 	<ul style="list-style-type: none"> Memory: <ul style="list-style-type: none"> 128MB (minimum) 256MB (recommended) Disk Space: <ul style="list-style-type: none"> 110MB Network Protocol: <ul style="list-style-type: none"> TCP/IP (http/https)
Vianet Backup Manager Lite 	<ul style="list-style-type: none"> Windows 2000 / XP / 2003 / Vista Mac OS X 10.3+ 	<ul style="list-style-type: none"> Outlook / Outlook Express i.e. *.pst, *.dbx and *.wab Other common files e.g. *.doc, *.xls Also supports backing up of: <ul style="list-style-type: none"> Windows NTFS access privileges 	<ul style="list-style-type: none"> Memory: <ul style="list-style-type: none"> 128MB (minimum) 256MB (recommended) Disk Space: <ul style="list-style-type: none"> 110MB Network Protocol: <ul style="list-style-type: none"> TCP/IP (http/https)

2 Installing Vianet Backup Manager

Before you can start backing up data to the Backup Server (Vianet Online Backup), you need to install the Online Backup Manager onto your computer.

2.1 Installing Vianet Backup Manager for Windows

1. Download the Vianet Backup Manager installer from <http://www.vianet.ca/software.php>
2. Follow the instructions on the installation wizard to complete installation
3. When finished, a new icon (Vianet Backup Manager / Vianet Backup Manager Lite) will be installed to the system tray (near the clock) automatically and Vianet Backup Manager / Vianet Backup Manager Lite will be launched automatically.
4. Logon to the server with your username and password.
5. If this is your first time logging into the server, you will be prompted to create a backup set:
 - i. Enter a backup set name of your choice in the [Name] field and choose the type of backup set in the [Type] field
 - ii. Select the files that you want to backup
 - iii. Setup the backup schedule by pressing the [Add] button (please note that you can add multiple backup schedules to a backup set and please select the "Run scheduled backup on this computer" checkbox if you would like to run Continuous Data Protection (CDP))
 - iv. Press the [OK] button to complete the configuration of backup set Schedule. Backup will run automatically if you leave your computer on.
6. To run a backup immediately, click [Backup] button on the left panel, select the backup set and press [OK] button.
7. Setup completed.

2.2 Installing Vianet Backup Manager for Mac OS X

1. Download the Vianet Backup Manager installer from <http://www.vianet.ca/software.php>.
2. Expand the archive and run the installation wizard within the archive.
3. Restart your Mac. Double click the desktop Vianet Backup Manager / Vianet Backup Manager Lite icon to start.
4. Logon to the server with your current username and password.
5. If this is your first time logging into the server, you will be prompted to create a backup set:
 - i. Setup the backup schedule by pressing the [Add] button (please note that you can add multiple backup schedules to a backup)
 - ii. Press the [OK] button to complete the configuration of backup setScheduled backup will run automatically if you leave your computer on.
6. To run a backup immediately, click [Backup] button on the left panel, select the backup set and press [OK] button.
7. Setup completed.

2.3 Installing Vianet Backup Manager for Linux/Unix/Solaris

Linux

1. Download the Vianet Backup Manager tarball release from <http://www.vianet.ca/software.php>.
2. Unpack the install file to /usr/local/obm

```
# mkdir /usr/local/obm  
# cd /usr/local/obm  
# gunzip obm-nix.tar.gz  
# tar -xf obm-nix.tar
```

3. Install Vianet Backup Manager

```
# ./bin/install.sh >install.log
```

All installation information can be found in the file "install.log"

The backup scheduler and auto upgrade services are automatically installed. Backup sets can now run at their scheduled times automatically. *

4. Please go to X Window or command line mode to continue installation

Solaris

1. Download the Vianet Backup Manager tarball release (obm-nix.tar.gz) from the website.
2. Unpack the install file to /usr/local/obm

```
# mkdir /usr/local/obm  
# cd /usr/local/obm  
# gunzip obm-nix.tar.gz  
# tar -xf obm-nix.tar
```

3. Remove bundled jvm

```
# rm -rf /usr/local/obm/jvm
```

4. Install J2SE Java Runtime Environment (JRE) 1.4.x or later to /usr/java
5. Create a symbolic link for JRE

```
# ln -s /usr/java /usr/local/obm/jvm
```

6. Set the JAVA_HOME environment variable

```
# JAVA_HOME=/usr/java; export JAVA_HOME
```

7. Install Vianet Backup Manager

```
# ./bin/install.sh >install.log
```

All installation information can be found in the file "install.log"

The backup scheduler and auto upgrade services are automatically installed. Backup sets can now run at their scheduled times automatically. *

8. Please go to X Window or command line mode to continue installation.

BSD

1. Download the Vianet Backup Manager tarball release from <http://www.vianet.ca/software.php>.
2. Unpack the install file to /usr/local/obm

```
# mkdir /usr/local/obm
# cd /usr/local/obm
# gunzip obm-nix.tar.gz
# tar -xf obm-nix.tar
```

3. Remove bundled jvm

```
# rm -rf /usr/local/obm/jvm
```

4. Download J2SE Java Runtime Environment (JRE) 1.4.x or later

Depending on your platform and BSD release, download the corresponding JRE and dependant packages. For example, we are using FreeBSD 6.1 i386 for installation:

Download javavmwrapper-2.3.tbz and diablo-jre-freebsd5.i386.1.5.0.07.01.tbz in the following links.

<http://www.freebsd-fr.org/ports/java.html#javavmwrapper-2.3>

<http://www.freebsdoundation.org/downloads/java.shtml>

http://www.freebsd.org/ports/java.html#diablo-jre-1.5.0.07.01_3 (See package dependency of your machine)

5. Install J2SE Java Runtime Environment (JRE) 1.4.x or later to /usr/local/diablo-jre1.5.0

Use following command to install package

```
# pkg_add javavmwrapper-2.3.tbz
# pkg_add diablo-jre-freebsd5.i386.1.5.0.07.01.tbz
```

6. Create a symbolic link for JRE

```
# ln -s /usr/local/diablo-jre1.5.0 /usr/local/obm/jvm
```

If you are using csh as your shell, you need to type "rehash" and hit enter to make the symbolic link take effect. For other shell types it should work.

```
# setenv JAVA_HOME /usr/local/obm/jvm
```

7. Verify the installed JRE

```
$JAVA_HOME/bin/java -version
```

See if the output does not contain warning

With warning

```
Java HotSpot(TM) Client VM warning: Can't detect initial thread stack location java version "1.4.2_12"
Java(TM) 2 Runtime Environment, Standard Edition (build 1.4.2_12-b03)
Java HotSpot(TM) Client VM (build 1.4.2_12-b03, mixed mode)
```

Without warning

```
java version "1.5.0"
Java(TM) 2 Runtime Environment, Standard Edition (build diablo-1.5.0-b01)
Java HotSpot(TM) Client VM (build diablo-1.5.0_07-b01, mixed mode)
```

8. Install Vianet Backup Manager

```
# ./bin/install.sh >install.log
```

All installation information can be found in the file "install.log"

9. Install the backup scheduler and auto upgrade services

Add two entries to system file /etc/rc.conf for auto starting backup scheduler and auto upgrade agent.

```
# obmaua_enable="YES"  
# obmscheduler_enable="YES"
```

Restart computer or run the following scripts

```
# /usr/local/etc/rc.d/obmscheduler start &  
# /usr/local/etc/rc.d/obmaua start &
```

The backup scheduler and auto upgrade services are automatically installed. Backup sets can now run at their scheduled times automatically. *

10. Please go to X Window or command line mode to continue installation.

X-Windows

1. Set the DISPLAY environment variables

Linux / Unix (sh, bash): `DISPLAY=IP_ADDRESS_OF_XTERMINAL[:0.0]; export DISPLAY`

For example

```
DISPLAY=:0.0; export DISPLAY  
or DISPLAY=127.0.0.1; export DISPLAY  
or DISPLAY=127.0.0.1:0.0; export DISPLAY  
or DISPLAY=192.168.0.2; export DISPLAY  
or DISPLAY=192.168.0.2:0.0; export DISPLAY
```

BSD (csh): `setenv DISPLAY IP_ADDRESS_OF_XTERMINAL[:0.0]`

For example

```
setenv DISPLAY :0.0  
or setenv DISPLAY 127.0.0.1  
or setenv DISPLAY 127.0.0.1:0.0  
or setenv DISPLAY 192.168.0.2  
or setenv DISPLAY 192.168.0.2:0.0
```

2. Run the Vianet Online Backup Manager

```
# sh /usr/local/obm/bin/BackupManager.sh &
```

3. Logon to the server with your username and password.

4. If this is your first time logging into the server, you will be prompted to create a backup set

- i. Enter a backup set name of your choice in the [Name] field and choose the type of backup set in the [Type] field
- ii. Select the files that you want to backup
- iii. Setup the backup schedule by pressing the [Add] button (please note that you can add multiple backup schedules to a backup set)
- iv. Press the [OK] button to complete the configuration of backup set

5. To run a backup immediately, click [Backup] button on the left panel, select the backup set and press [OK] button.

6. Setup completed.

Command Line Mode

1. Use the web interface to add, update and remove backup sets

- i. If you want to update a backup set, make changes to a backup set and press the [Update] button
Enter your [Email] in the text field provided
- ii. If you want to add a new backup set, click the [Add] link
- iii. If you want to remove a backup set, Select the backup set to be remove and click the [Remove]

link

- Using Backup Configurator

```
# sh /usr/local/obm/bin/Configurator.sh
```

- Enter your Login Name, Password, Backup Server URL and proxy setting as shown below

```
Login Name: userXXX  
Password: *****  
Backup Server URL: backup.vianet.ca  
Which Protocol ? (1) Http (2) Https : 1  
Use proxy ? (Y)es or (N)o : N  
Proxy Type ? (1) Http/Https Proxy (2) SOCKS : 1  
Enter proxy server :  
Enter proxy port :  
Enter proxy username (optional) :  
Enter proxy password (optional) :
```

- If you want to make any changes to the setting above, you can use the main menu below to do so.

Main Menu:

```
(1). List Backup Setting  
(2). Change Password  
(3). Change Network Setting  
(4). Change run scheduled backup setting  
(5). Toggle Masked Field (Password, Encryption Key)  
(6). Generate Configuration Report (text format)  
(7). Quit
```

Your Choice:

- You can then run a backup by executing the command below.

```
# sh /usr/local/obm/bin/RunBackupSet.sh [BACKUP_SET]
```

where [BACKUP_SET] is the name of backup set to be run

- Setup completed.

* The backup scheduler and auto upgrade services are verified to install successfully on Solaris, FreeBSD and all major Linux distributions. If these services for other platforms cannot be installed, please refer to the specific OS manual for further information.

2.4 Installing Vianet Backup Manager for Netware

1. Download the Vianet Backup Manager zip release from <http://www.vianet.ca/software.php>.
2. Expand the zip file to SYS:\Vianet Backup Manager
3. Install Vianet Backup Manager

```
SYS:\> SYS:\OBM\aua\bin\install-aua.ncf
```
4. Start Auto Upgrade Agent

```
SYS:\> SYS:\OBM\aua\bin\startup.ncf
```
5. If you want scheduled backup to run automatically, you must start the backup scheduler by

```
SYS:\> SYS:\OBM\bin\Scheduler.ncf
```

All backup sets will now be run at their scheduled times automatically.
6. Open Vianet Backup Manager by running SYS:\Vianet Backup Manager\bin\RunBackupManager.ncf
7. (Optional) Enter the backup server host name in the [Address] field and press the [Next] button.
8. If you don't have a backup account, register a trial user by the following steps:
 - i. Enter the [Login Name], [Password] and [Confirm Password] of your choice
 - ii. Enter your [Email] in the text field provided
 - iii. Press the [Submit] button
 - iv. You should be logged to the backup server already (if the [Login Name] of your choice is already taken by another user, try a different login name)
9. If you have a backup account already, select [already a user?] and logon to the server with your existing username and password.
10. If this is your first time logging into the server, you will be prompted to create a backup set
 - i. Enter a backup set name of your choice in the [Name] field and choose the type of backup set in the [Type] field
 - ii. Select the files that you want to backup
 - iii. Setup the backup schedule by pressing the [Add] button (please note that you can add multiple backup schedules to a backup set and please select the "Run scheduled backup on this computer" checkbox if you would like to run Continuous Data Protection (CDP))
 - iv. Setup the encryption setting for your backup set (if you don't know much about encryption, just accept the default values here)
 - v. Press the [OK] button to complete the configuration of backup set
11. To run a backup immediately, click [Backup] button on the left panel, select the backup set and press [OK] button.
12. Setup completed.

3 Uninstalling Vianet Backup Manager

This section describes the steps required to uninstall Vianet Backup Manager from your computer.

3.1 Uninstalling Vianet Backup Manager for Windows

1. Open [Start] -> [Control Panel] -> [Add/Remove Programs]
2. Select [Vianet Online Backup Manager] from the list and press the [Remove] button

3.2 Uninstalling Vianet Backup Manager for Mac OS X

1. Remove all program files by running

```
# cd $OBM_HOME/bin
# sudo ./uninstall.sh
```
2. Remove all backup setting by removing ~/.obm

```
# rm -rf ~/.obm
```
3. Restart your computer

3.3 Uninstalling Vianet Backup Manager for Linux/Unix/Solaris

1. Run the uninstall scripts

```
# sh /usr/local/obm/bin/uninstall.sh
```

```
Removing Scheduler from service using script name obmscheduler
Using init script path /etc/init.d
Using run level script path /etc/rc.d
Removing symbolic link from run levels
Removing script file obmscheduler from /etc/init.d
Shutting down AutoUpdateAgent
Waiting 5 seconds for AutoUpdateAgent to clean up
Removing AutoUpdateAgent from service using script name
Using init script path /etc/init.d
Using run level script path /etc/rc.d
Removing symbolic link from run levels
Removing script file obmaua from /etc/init.d
Online Backup Manager uninstall service is complete!
It is now safe to remove files from /usr/local/obm
```
2. Remove installed files and all application data

```
#rm -rf /usr/local/obm
#rm -rf ~/.obm
```
3. Uninstall completed.

3.4 Uninstalling Vianet Backup Manager for Netware

1. Stop the running backup scheduler by running

```
SYS:\> touch SYS:\OBM\ipc\Scheduler\stop
```
2. Stop the running auto upgrade agent by running

```
SYS:\> SYS:\OBM\aua\bin\shutdown.ncf
```

3. Remove all program files by removing the directory **SYS:\OBM**
4. Remove all backup settings by removing the directory **SYS:\.OBM**

4 Using Vianet Backup Manager

This chapter will describe all the features available in Vianet Backup Manager and outline how you can use Vianet Backup Manager to meet various backup needs.

4.1 System Tray Launcher (Windows Only)

After you have successfully installed Vianet Backup Manager onto your computer, a Vianet Backup Manager icon will be added to the system tray area (next to your system clock) automatically.

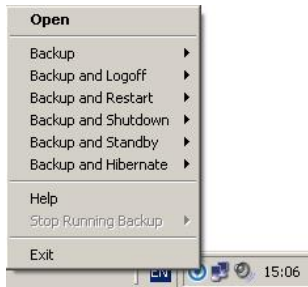

This icon is the entry point to Vianet Backup Manager. Right clicking the icon will show a menu that provides the following functions:

Menu Item	What it does
Open	Run Vianet Backup Manager.
Backup	Runs a specific backup set (or all backup sets) chosen from the sub-menu in silent background mode.
Backup and Logoff	Runs a specific backup set (or all backup sets) chosen from the sub-menu in silent background mode and then logoff from Windows when finished.
Backup and Restart	Runs a specific backup set (or all backup sets) chosen from the sub-menu in silent background mode and restart Windows when finished.
Backup and Shutdown	Runs a specific backup set (or all backup sets) chosen from the sub-menu in silent background mode and shutdown the computer when finished.
Backup and Standby	Runs a specific backup set (or all backup sets) chosen from the sub-menu in silent background mode and enter the Standby mode of Windows.
Backup and Hibernate	Runs a specific backup set (or all backup sets) chosen from the sub-menu in silent background mode and enter the Hibernate mode of Windows.
Help	Shows a help dialog
Stop running backup	Interrupts a running backup set (or all backup sets) chosen from the sub-menu.
Exit	Close this system tray launcher application.

4.2 Logon Dialog

Before you can use Vianet Backup Manager, you have to be authenticated. Enter your username and password when prompted.

If you need to connect to the server through proxy, just enter your proxy setting in the [Proxy Setting] section. For [SOCKS] proxy, both v4 and v5 without user authentication are supported.

4.3 Language Selection

You can switch the language of the Vianet Backup Manager user interface by choosing the desired language available from the [Language] drop down list. The languages available includes English, Czech, Danish, Dutch, French, Spanish, Portuguese, Icelandic, Norwegian, Finnish, Italian, German, Swedish, Chinese (Traditional and Simplified), Japanese, Lithuanian and Slovenian.

4.4 Main Window

Press [OK] to logon. After the backup server authenticates you successfully, the Vianet Backup Manager main window appears.

4.5 Backup Logs

All backup activities are logged to backup activity log files. They are available for reviewing from Vianet Backup Manager.

How to review backup activities?

You can review all your backup Jobs by

1. Press the [Backup Log] button on the Vianet Backup Manager main window.
2. Select the Backup Set you want to review from the [Backup Set] drop down list.
3. Select the Backup Job you want to review from the [Log] drop down list.

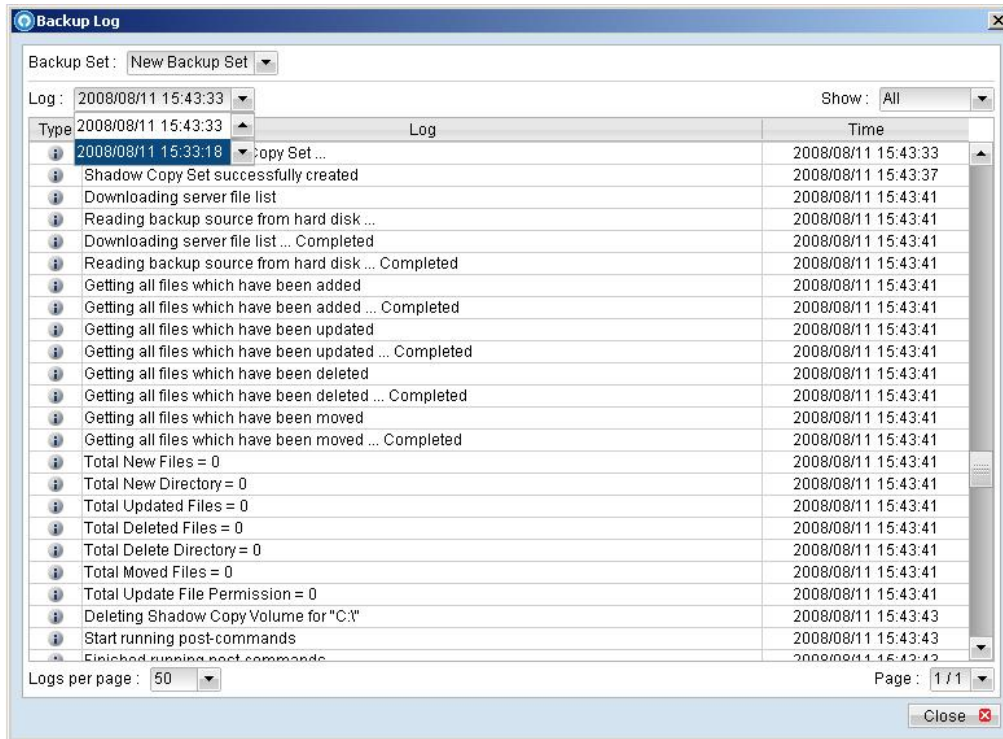



5 Setting Up Backup Sets (Unavailable in Lite Version)

A backup set contains all backup settings of a backup operation. This section will describe all features available within a backup set and explain how you can use each of them to achieve various tasks.

Each backup account can have multiple backup sets. Each backup set is an individual and independent entity. For example, if you want one directory to be backed up during the day and another directory to be backed up during the night, you can create two backup sets, each with a different backup schedule and backup source, to serve this need.

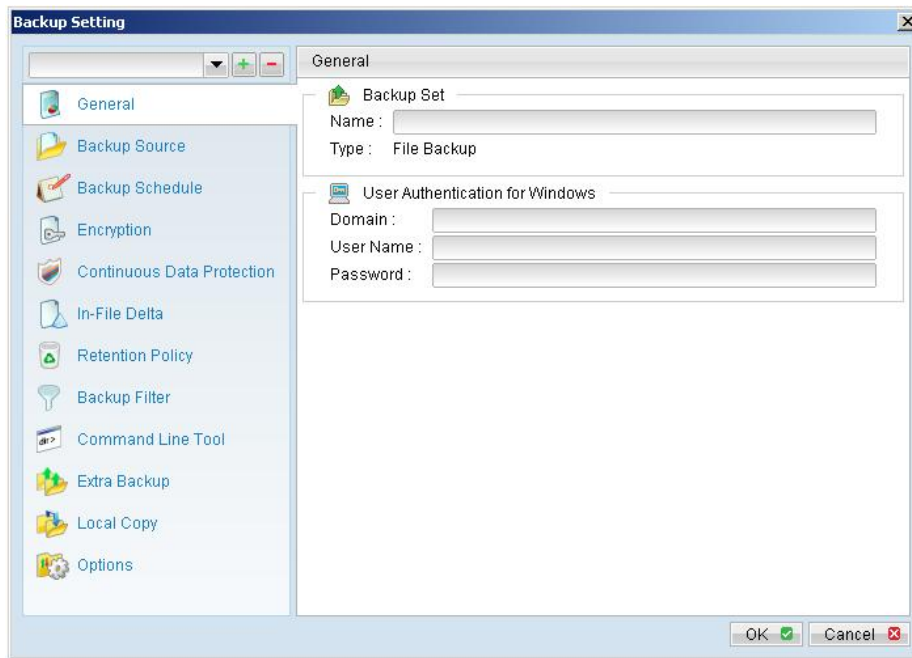
To start setting up backup sets, click the  button to open the [Backup Setting] dialog. As an example, let's create a "File Backup Set" for the rest of this chapter.



On the left panel, press the  button to create a new backup set.

5.1 Backup Set Type

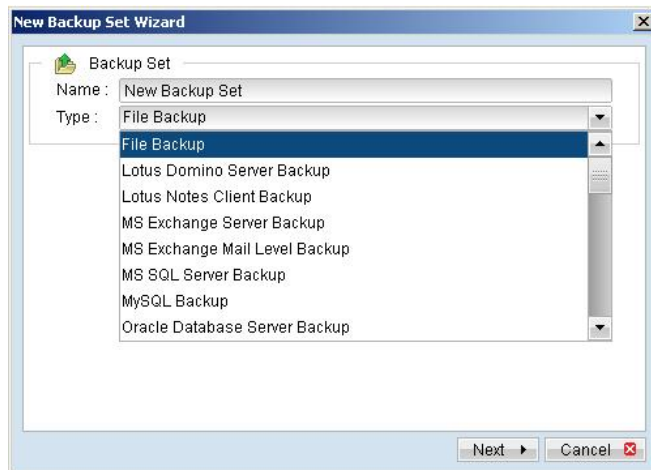

A backup set can be of one of the following types:

Backup Type	Description
File	Backup set type to backup common files/directories
Lotus Domino Server	Backup set type to backup Lotus Domino
Lotus Notes Client	Backup set type to backup Lotus Notes
MS Exchange Server	Backup set type to backup Microsoft Exchange Server 2000 / 2003 / 2007
MS Exchange Mail Level	Backup set type to backup individual emails, contacts, calendars, tasks etceteras from Microsoft Exchange Server 2000 / 2003 /2007
MS SQL Server	Backup set type to backup Microsoft SQL Server 7.0 / 2000 / 2005
MySQL Server	Backup set type to backup MySQL Server
Oracle Database Server	Backup set type to backup Oracle 8i/9i/10g database
System State	Backup set type to backup Microsoft Window's System State

Backup set type is defined at backup set creation and cannot be modified. If you want to change the backup set type, you have to create another backup set in the new backup set type.

5.2 Backup Source

A "Backup Source" defines the files/directories that are to be included in a backup set. There are two types of backup source: Selected and Deselected. Selected backup source defines files/directories that are to be included in a backup set while deselected backup source defines files/directories that are to be excluded from a backup set. Vianet Backup Manager will generate appropriate backup source setting for you automatically when you make your backup source selection.

Please note that for Windows operating systems, if the "Hide protected operating files (Recommended)" setting is enabled for the file explorer, system folders/files will not be shown in the backup source. By selecting the parent folders however, all subfolders (including system folders/files) will be included in the backup set. Thus if you want to exclude system folders (e.g. recycle bin) from the backup, please select the desired folders/files directly rather than selecting the parent folder. Alternatively, you can enter the corresponding system path to the [Exclude List] of the backup set using the web interface.

On the first screen of the dialog, you can easily select the following common folders to be backed up:

1. "Desktop" folder
2. "My Documents" folder
3. "Favorites" folder
4. "Outlook" and "Outlook Express" mail store folder

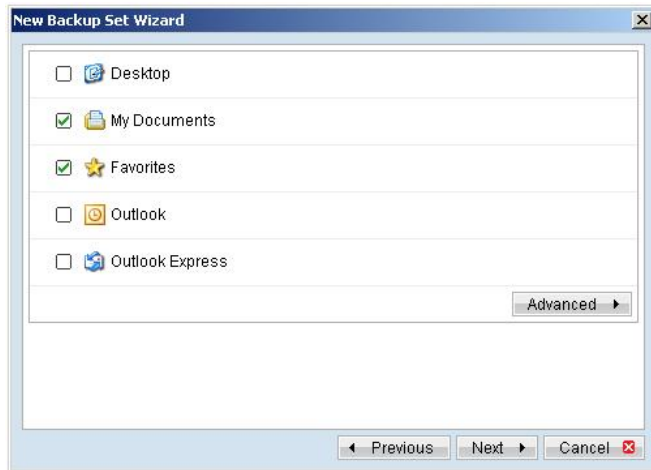

On clicking the [Advanced] button, you can easily select other common folders to be backed up as well.

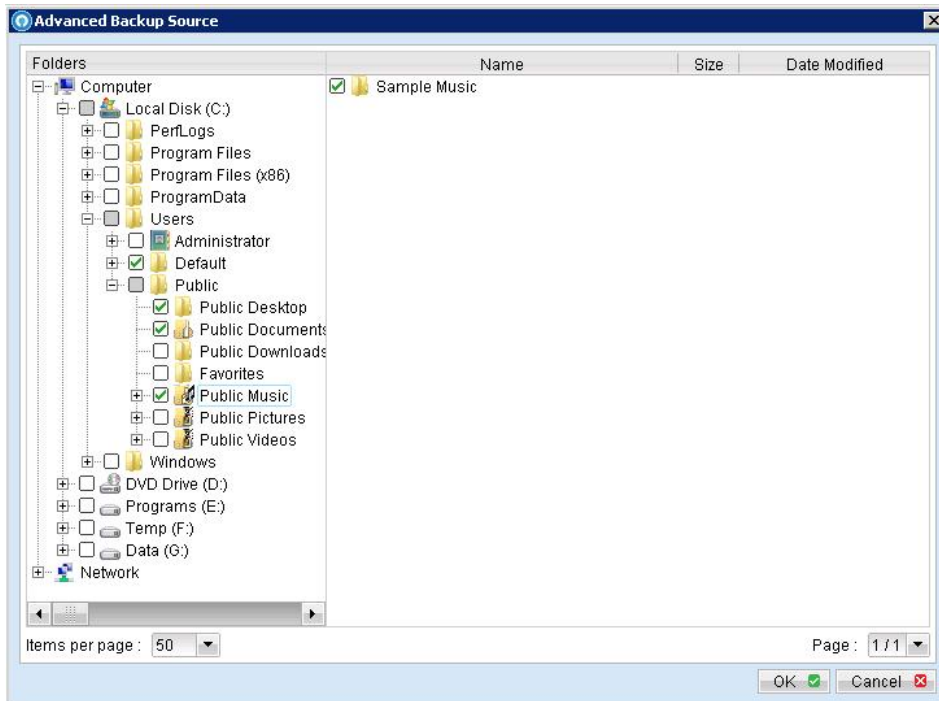

The checkbox next to the files/directories shown above can be in one of the following mode:

Mode	Description
<input checked="" type="checkbox"/>	All files/directories (recursively) under this directory will be backed up
<input checked="" type="checkbox"/>	All files/directories (recursively), except those explicitly excluded, under this directory will be backed up. If you add files/directories to this directory in the future, they will be backed up as well.
<input type="checkbox"/>	Only the checked files/directories under this directory will be backed up. If you add files/directories to this directory in the future, they will NOT be backed up.
<input type="checkbox"/>	Nothing under this directory will be backed up.

By clicking on the boxes, you can change the modes of each file/directory, in order to create a set of files to be backed up.

You can change the backup source anytime after creating the backup set, by clicking the [Backup Source] node of the left panel on the [Backup Setting] dialog.

5.3 Backup Schedule

A "Backup Schedule" defines the frequency and the time that backups should run automatically.

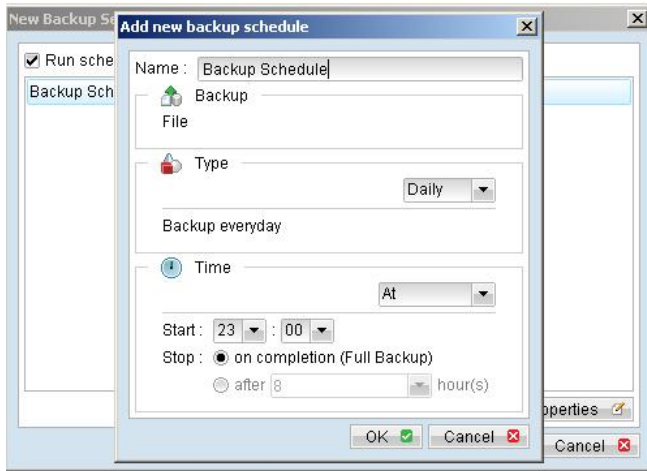

Backup schedule can be in one of the following types:

Type	Description
Daily	Backup Jobs will run everyday
Weekly	Backup Jobs will run on the specified day(s) of every week
Monthly	Backup Jobs will run on the specified day or on a day with a given criteria (e.g. first weekend, last weekday) of every month
Custom	Backup job will run once on any particular date

For each schedule type above, backup will run at the scheduled time for a maximum of the duration specified (or until all data are backed up if [Stop on backup completion] option is chosen). If a backup job does not finish within the maximum duration specified, it will be interrupted.

Please note that you can have more than one schedule within a backup set. For example, you can have a daily backup schedule that runs at 13:00 at noon and another daily backup schedule that runs at 00:00 at midnight. The combination of these schedules effectively creates a backup schedule that runs daily at 00:00 and 13:00 every day.

You can change the backup schedules anytime after creating the backup set, by clicking the [Backup Schedule] node of the left panel on the [Backup Setting] dialog.

5.4 Continuous Data Protection (CDP)

Note: Continuous Data Protection feature is disabled by default. This feature can be enabled under options.

Vianet Backup Manager / Vianet Backup Manager Lite Continuous Data Protection (CDP) feature enables files to be backed automatically at the time when there are changes to files on local hard disks. The benefits of using CDP are:

1. All intra-day interim changes are backed up automatically. Even if the computer breaks down completely before users had the change to backup their data at the end of the day in logout backup reminder, all changes within the day have been backed up safely by CDP and no data are lost.
2. Sometimes users do not save their data in the folders designated as backup source path and thus results in data not being backed up even when backup runs. Since CDP tracks all changes of files on local hard disk automatically for users, all files changed by the users are automatically backed up no matter whether the files are located in the backup source paths or not. This makes defining a backup set a much easier task for both administrators and users.

Although CDP is a very helpful feature, it does have some drawbacks. For example, a memory resident program,

which tracks file changes to the file system and backs up files continuously in background, consumes both a computer's CPU and memory resources. It can potentially slow down a computer considerably. For application servers, e.g. Microsoft Exchange Server or Microsoft SQL Server, that does not require CDP features (you can use transaction log backup interval of as frequent as every 1 minute to mimic a continuous backup strategy instead), please turn off CDP by changing the startup method of [Control Panel] -> [Administrative Tools] -> [Services] -> [Continuous Data Protection (Vianet Backup Manager)] -> [General] -> [Startup type] to "manual".

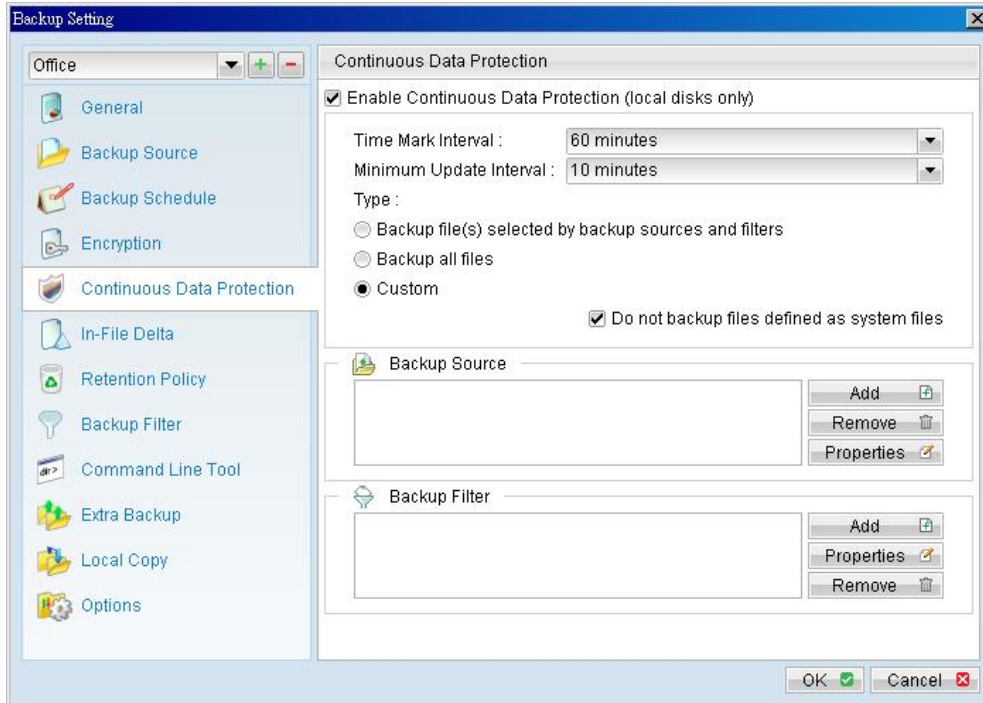

The following table explains all CDP parameters available within a backup set.

Parameter	Description
Enable Continuous Data Protection (local disk only)	It defines whether CDP is enabled in this backup set. Please note that CDP will only backup files on local hard disks, not files on floppy drives, removable drives and network mapped drives.
Time Mark Interval	Not available in Lite client (Defaults to every 60 minutes) It defines the interval of point-in-time views generated by CDP. For example, if this setting is set to "60 minutes", the point-in-time views selectable under Vianet Backup Manager / Vianet Backup Manager Lite restore wizard and Vianet Online Backup File Explorer will be "00:00", "01:00", "02:00" etc, for each day.
Minimum Update Interval	Not available in Lite client (Defaults to every 10 minutes) It defines the minimum interval that repeatedly updated files are backed up again. For example, if a file is updated every minute and the [Minimum Update Interval] is set to "10 minutes", CDP backs up this file every 10 minutes instead of every minute. If you want all changes to be backed up instead, please change this setting to "Always". However, since Vianet Online Backup keeps only 1 snapshot of file within a single point-in-time view ("Time Mark Interval"), only the last backup file within each point-in-time view is restorable from Vianet Online Backup, all other interim backup files are overwritten automatically without notice. Please note that this applies to all full file backup only, but not for files that are backed up incrementally by in-file delta. To maintain a valid in-file delta chain for incremental delta files, Vianet Online Backup will not delete incremental delta files automatically. If you are interested in restoring any of these snapshots backed up, you can use the [Show all files] view to display all interim incremental backup files.
Type	[Backup file(s) selected by backup sources and filters] – when this option is selected, CDP will only back up all changed files selected by backup set sources and filters settings

	<p>[Backup all files] – when this option is selected, CDP will only back up all changed files</p> <p>[Custom] – when this option is selected, CDP will only back up changed files selected by CDP backup sources and CDP backup filters settings</p>
Do not backup files defined as system files	<p>If this option is enabled, CDP will exclude the following files from its backup:</p> <ol style="list-style-type: none"> 1. '[WINDOWS_DIR]' (e.g. C:\WINDOWS*) 2. '[PROGRAM_DIR]' (e.g. C:\Program Files*) 3. '[RECYCLE_BIN_DIR]' (e.g. C:\RECYCLER, D:\\$Recycle.Bin) 4. '[ALL_LOCAL_DRIVE]:\Pagefile.sys' (e.g. C:\Pagefile.sys, D:\Pagefile.sys) 5. '[ALL_LOCAL_DRIVE]:\hiberfil.sys' (e.g. C:\hiberfil.sys, D:\hiberfil.sys) 6. '[ALL_LOCAL_DRIVE]:****.tmp' (e.g. C:\xxx\abc.tmp, D:\yyy\abc.tmp) 7. '[ALL_LOCAL_DRIVE]:\System Volume Information' (e.g. C:\System Volume Information, D:\System Volume Information) 8. '[APP_DATA]\Microsoft' 9. '[APP_DATA]\Kaspersky Lab' 10. '[APP_DATA]\Symantec' 11. '[APP_DATA]\Avg7' 12. '[APP_DATA]\Avg8' 13. '[APP_DATA]\McAfee' 14. '[APP_DATA]\McAfee.com' 15. '[APP_DATA]\Sophos' 16. '*\ntuser.dat' 17. '*\Application Data\Mozilla**' 18. '*\Local Settings\Application Data\Microsoft**' 19. '*\Application Data\Macromedia**' 20. '~\$*. (doc dot ppt xls DOC DOT PPT XLS)' 21. '*\Local Settings\Temp\Temporary Internet Files\History**' 22. '*\LOCALS~1\Temp\Tempor~1\History**' <p>where [APP_DATA] = "C:\Documents and Settings\All Users\Application Data" (XP) or "C:\ProgramData" (Vista)</p> <p>If you are interested in contributing to the maintenance of this by adding your suggestions, please contact us.</p>
Backup Source	<p>Not available in Lite Client (Please use the main backup source option)</p> <p>This option is only available when [Custom] CDP type is selected. When this option is used, CDP will only backup the files under the paths defined and all other files are ignored.</p>
Backup Filter	<p>Not available in Lite Client (Please use the Backup Set Filter option)</p> <p>This defines whether any file will be backed up by CDP. When CDP type is [Backup all files], it is only possible to exclude files from CDP backup. CDP backup filter is similar to backup set filter, please refer to Backup Filter section for more information.</p>

5.5 Encryption

The encryption key will be your login password.

5.6 Mapped Network Drive

If you need to backup a mapped network drive on Windows (it will only work in Windows NT/2000/XP/2003/Vista), you must enter your Window's domain, username and password into the [Network Resources Authentication for Windows] section as shown below. It is required because scheduled backups will always run under the context of Window's "Local System" account (which does not have the privileges required to access network resources) by default. Vianet Backup Manager needs to collect your Windows username, password and domain name to authenticate itself to the windows domain controller to acquire the required access privileges to the network files to be backed up. If you don't supply a username and password, Vianet Backup Manager will have problems accessing network resources in its scheduled backup Jobs.

If you need to backup network mapped drive in scheduled backup, please do this:

- i. Select the backup set from the drop down list at the top of the left panel

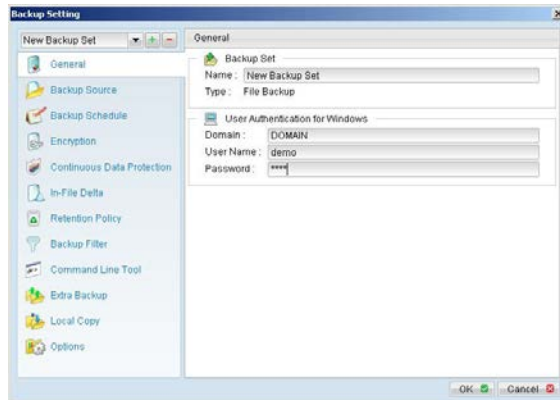

- ii. Enter your Windows domain, username and password into the right panel and press [OK]
- iii. Press the [OK] button to save.

The steps above apply only to computers running in a Windows domain. If you don't have a windows domain with your network and you are using a workgroup or using a NetWare server, please use the "net use" command to authenticate the running backup process against the computer hosting the mapped drive. Otherwise, you will get "Access Denied" error from the backup report.

For example, if you want to backup \\SERVER\SHARE that is located on a NetWare server (or another computer in a windows workgroup) and you are getting "Network drive is not accessible" error message, please try adding the following command as a [Pre-backup command]

```
net use \\SERVER\SHARE [PASSWORD] /USER:[DOMAIN | MACHINE_NAME]\[USERNAME]
```

E.g.

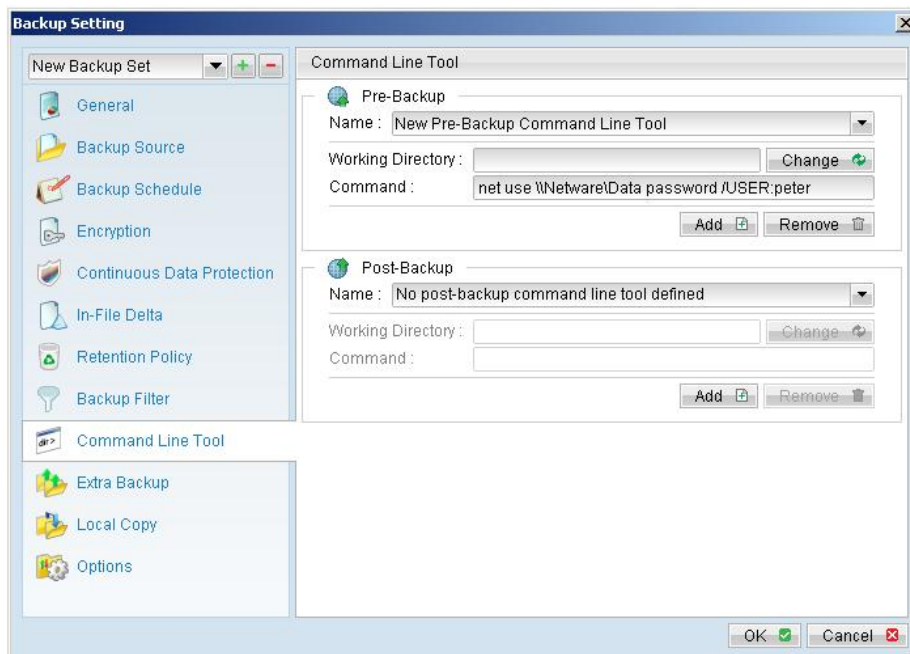

Enter one of the following commands directly into the Pre-Backup Command:

```
net use \\Netware\Data password /USER:peter
net use \\WorkgroupComputer1\Data password /USER:WorkgroupComputer1\peter
```

This will authenticate the current process with the NetWare server (or another computer in a windows workgroup) and backup will then run correctly.

5.7 Backup Filter

A "Backup Filter" defines the file selection rules that allow user to easily include/exclude files into/from the backup set by applying user defined criteria(s) to the file names or directory names.

There are some basic rules regarding backup filters:

- i. Filters are checked in creation order. Once inclusion/exclusion has been identified, the remaining filters won't be checked.
- ii. Inclusion/Exclusion made by filter always takes precedence over backup source selections
- iii. If all filters do not apply to a particular file, this file is then checked for inclusion/exclusion backup source selections

To add a new filter, press the [Add] button at the bottom of the right panel.

Note: To access the backup filter in the Lite Client, Click Backup Source > Click Advanced > and Click Backup Filter on the bottom left hand corner of the screen.

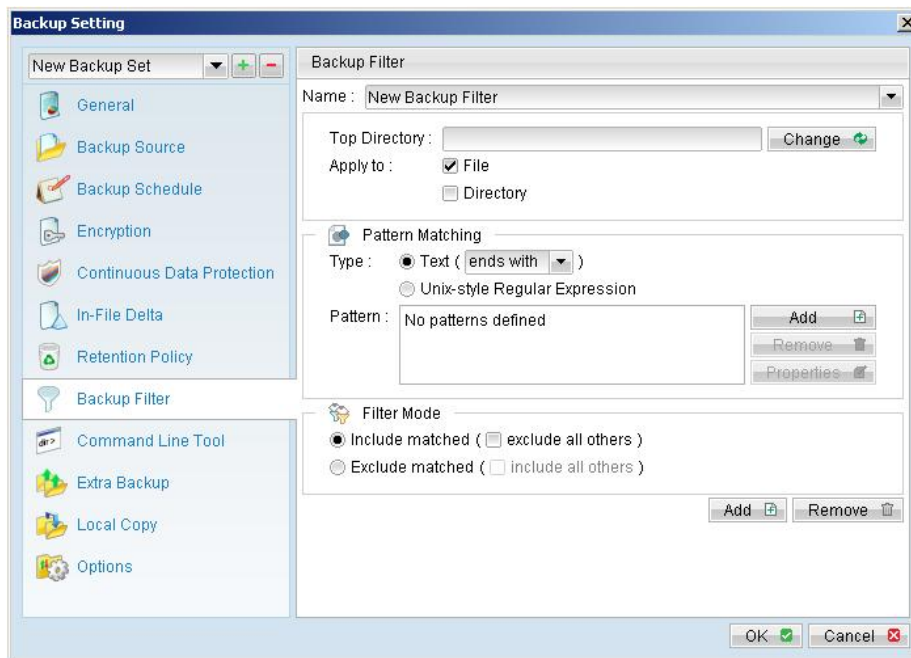

Key	Description
Name	The name of a filter
Top Directory	The top directory to which this filter is applied. Filtering rules will be applied to all files and/or directories under this directory.
Apply To	Define whether to apply the filtering rule to files and/or directories
Pattern Matching	It defines the filtering rules of a filter. A filtering rule can be of one of the following types: <div style="display: flex; justify-content: space-between;"> <div style="width: 30%;">[Starts With]</div> <div style="width: 65%;">Include/Exclude all files/directories with name starting with a certain pattern. <u>For example:</u> You can use B* to match all files with name starting with a 'B' character</div> </div> <div style="display: flex; justify-content: space-between;"> <div style="width: 30%;">[Contains]</div> <div style="width: 65%;">Include/Exclude all files/directories with name</div> </div>

	<p>containing a certain pattern. <u>For example:</u> You can use *B* to match all files with name containing with a 'B' character</p> <p>[Ends With] Include/Exclude all files/directories with name ending with a certain pattern. <u>For example:</u> You can use *.doc to match all files with name ending with '.doc' (all Word documents)</p> <p>[Regular Expression] Include/Exclude all files/directories with name matching a regular expression.</p> <p>To add a new pattern, press the [Add] button in the [Pattern Matching] area.</p>
Filter Mode	Defines whether you want to include or exclude matched files into/from the backup set. Also, for those unmatched files, you can choose to exclude (if include filter type) or include (if exclude filter type) them into/from the backup set.

Example 1:

If you want to backup only Word, Excel and PowerPoint documents in your document directory (e.g. C:\My Documents), you should setup your backup filter as follows.

Top Directory = C:\My Documents
 Apply To = File (true)
 Matching Type = End With
 Matching Patterns = *.doc, *.xls, *.ppt
 Filter Mode = Include
 Exclude all others = True

Example 2:

If you want to backup all files, excluding all *.exe, *.dll and *.tmp, in C:\Applications, you should setup your backup filter as follows.

Top Directory = C:\Applications
 Apply To = File (true)
 Matching Type = End With
 Matching Patterns = *.exe, *.dll, *.tmp
 Filter Mode = Exclude
 Include all others = True

Example 3:

If you have made your selection of files (all under C:\) from the backup source setting but you want exclude all images (e.g. *.jpg and *.gif) from your selection, you should setup your backup filter as follows.

Top Directory = C:\
 Apply To = File (true)
 Matching Type = End With
 Matching Patterns = *.jpg, *.gif
 Filter Mode = Exclude
 Include all others = false

Please note that the [Include all others] setting is not enabled because you don't want to include all other files (NOT *.jpg, *.gif) under C:\ into the backup set.

Example 4: (advanced)

If you want to include everything, except the "log" directory, under C:\Applications into a backup set, you should setup your backup filter as follows.

Top Directory = C:\Applications
 Apply To = Directory (true)
 Matching Type = Regular Expression

Matching Patterns = ^log\$
Filter Mode = Exclude
Include all others = True

Example 5: (advanced)

If you want to include all directories named "log" from the backup set files with file name starting with "B" and ending with "*.doc" under C:\My Documents into the backup set, you can use a regular expression of "^B.*\doc\$" to do your selection. The filter backup can then be setup as follows.

Top Directory = C:\My Documents
Apply To = File (true)
Matching Type = Regular Expression
Matching Patterns = ^B.*\doc\$
Filter Mode = Include
Exclude all others = True

5.8 Pre/Post-Backup Command (Not Available in Lite Client)

The [Command Line Tool] feature has two major components, the [Pre-Backup] command and the [Post-Backup] command. You can use the [Pre-Backup] or [Post-Backup] commands to run any native OS (operating system) commands before or after running a backup job.

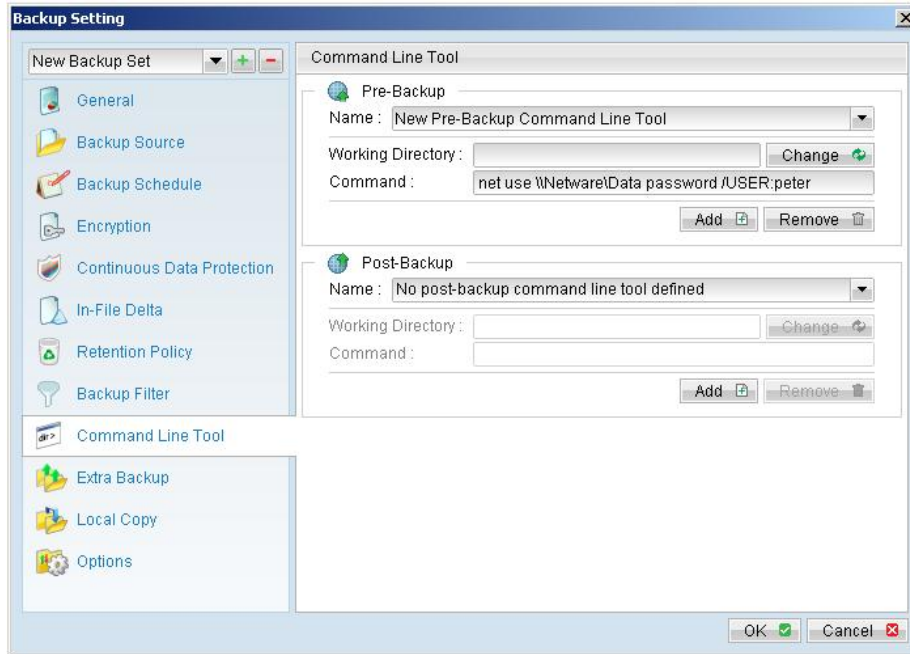

Both [Pre-Backup] and [Post-Backup] commands comprise of the following parameters:

Key	Description
Name	Name of this Command
Command	The command to be run (e.g. C:\My Documents\Application.exe or C:\My Documents\BatchJob.bat)
Working Directory	The directory at which this command will run

The backup set type affects the time at which [Pre-Backup] and [Post-Backup] commands run. The following table outlines when [Pre-Backup] and [Post-Backup] commands will run in different types of backup set.

Backup Set Type	When Pre-Backup Commands run?	When Post-Commands run?
File	Before uploading backup files	After uploading all backup files
Non-File Backup Sets (e.g. Microsoft SQL Server)	Before spooling backup files to temporary directory	After spooling backup files to temporary directory (i.e. before the first backup file is uploaded)

Note: You should never backup an application while it is running as this can result in inconsistent and unusable files getting backed up. Please use the "Volume Shadow Copy" feature if you're running Windows XP/2003/Vista or make use of the Pre-Backup Command feature to shut down your application before running a backup job and use the Post-Backup Command feature to restart your application after the backup job has completed.

For Example

You want to stop Microsoft Outlook using the Pre-Backup Command and restart it after backup using the Post-Backup Command, create the two following text files and assigned the files to Pre-Backup and Post-Backup Command.

1. Create a text file named "OutlookClose.vbs" using notepad with the following two lines:

```
Set objOLK = createObject("Outlook.Application")
```

```
objOLK.quit
```

2. Create a text file named "OutlookStart.bat" using notepad with the following line:

```
"C:\Program Files\Microsoft Office\OFFICE11\OUTLOOK.EXE"
```

5.9 Temporary directory

If you are running a file backup job with in-file delta enabled or a database type backup job, Vianet Backup Manager will generate temporary files and the directory that will be used to store all these files are defined by [Options] -> [Temporary directory for storing backup files]. Please set this to a non-system disk partition that has enough free space to avoid problems.

You can set the [Temporary directory for storing backup files] to a mapped network drive. If you choose to do this, please use a UNC path (e.g. \\SERVER\SHARE) and don't forget to configure the [Backup Set] -> [Network Resources Authentication for Windows] setting.

5.10 Transfer Block Size

Transfer block size defines the block size Vianet Backup Manager will use to transfer your backup blocks. Generally, backup jobs using a larger block size will have better performance, because of the smaller number of connections involved.

However, some firewalls or proxy servers may block out-going network traffic (HTTP/HTTPS POST method) with large block size for security reasons. If you are in a network with this type of restriction, please lower the transfer size value and try again.

To change the transfer block size of any backup set, please select the [Options] node on the left panel and then you can make changes to the [Transfer Block Size] under [Advanced Options]. After you have made your changes, just press the [OK] button to save.

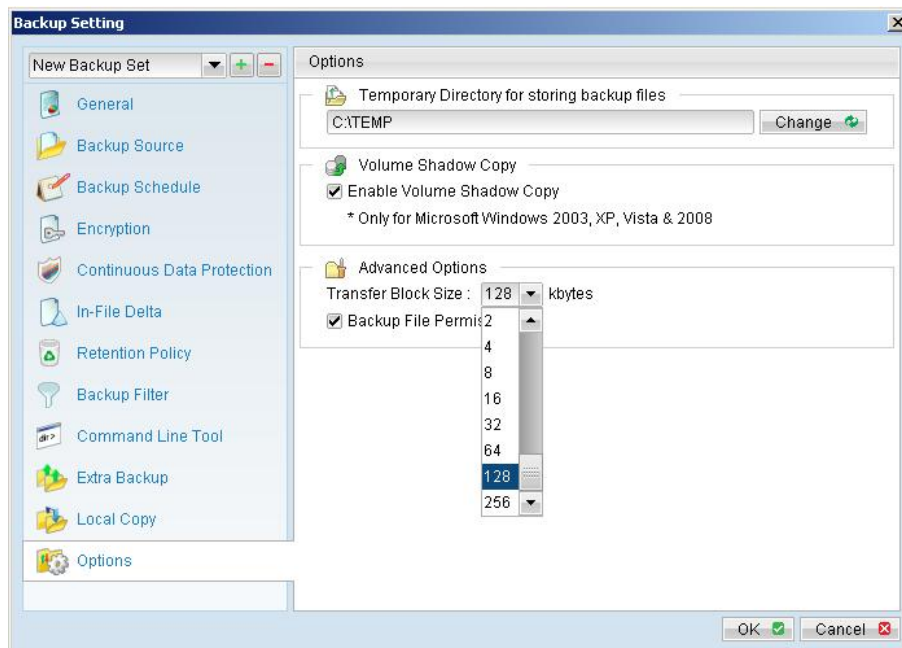

5.11 Follow Symbolic Link (Linux/Unix/Mac only)

Under Unix/Linux/Mac, users can create a symbolic link to link a file/directory from another directory. This setting defines whether you want Vianet Backup Manager to traverse any symbolic links encountered on your backup path.

To change the follow symbolic link of any backup set, please select the [Options] node on the left panel. You can then make changes to the [Follow Symbolic Link] by checking or un-checking the box. After you have made your changes, just press the [OK] button to save.

5.12 Microsoft's Volume Shadow Copy Service (VSS)

Microsoft Volume Shadow Copy Service (VSS) allows you to backup files that are exclusively opened. Without VSS, you will get the error message "The process cannot access the file because another process has locked a portion of the file" if you are trying to backup a file that is exclusively opened (e.g. Outlook PST file).

Please note that VSS is only available on Windows XP / 2003 / Vista and you must have administrative privileges to start the VSS service on a computer. Also VSS will only work if at least one of your partitions is formatted using NTFS.

If you are running Windows 2003, please install the Windows 2003 VSS hot fix available in <http://support.microsoft.com/default.aspx?scid=kb;en-us;887827> before running VSS.

If you are running into problems with VSS running on Windows XP / 2003, Microsoft's recommendation is to try re-registering the Volume Shadow Copy Service again. Simply run the script [OBM Home]\bin\RegisterVSS.bat to do so.

For more information, please take a look at the following page for a technical introduction to Volume Shadow Copy Services (VSS):

<http://technet2.microsoft.com/windowsserver/en/library/2b0d2457-b7d8-42c3-b6c9-59c145b7765f1033.mspx>

5.13 Retention Policy

Note: Retention policy settings are not available in the Lite Client. The Lite Client retention policy defaults to 7 days. Please [contact support](#) to change this setting.

During backup, if Vianet Backup Manager finds that you have deleted a file (or updated a file) on your computer, it will put the corresponding deleted (or updated) file already backed up on the backup server into a retention area. The retention policy setting defines how long files inside the retention area will be kept on the backup server before they are deleted automatically from the server.

Retention policy will only affect "retained" file (i.e. files that have already been deleted or updated on your computer and thus are moved to the retention area of the backup server). For those files that have not been updated on your computer, the backup of these files is kept in the data area on the backup server and won't be affected by the setting of retention policy. These backup files of unchanged files will stay on the backup server forever until the original files are removed (or updated) from your computer.

Standard Retention Policy

The standard retention policy allows you to delete retained files automatically after a user defined number of days or after a user defined number of backup Jobs. To change the retention policy setting of any backup set, please select the [Retention Policy] node on the left panel. You can then make changes to your retention policy under the [Retention Policy] section. After you have made your changes, just press the [OK] button to save.

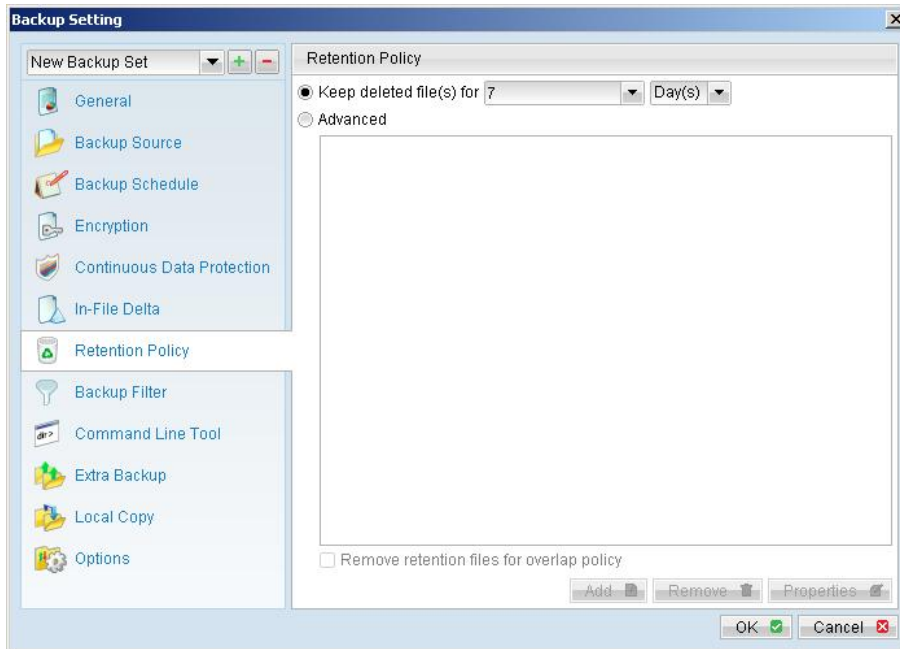

Advanced Retention Policy

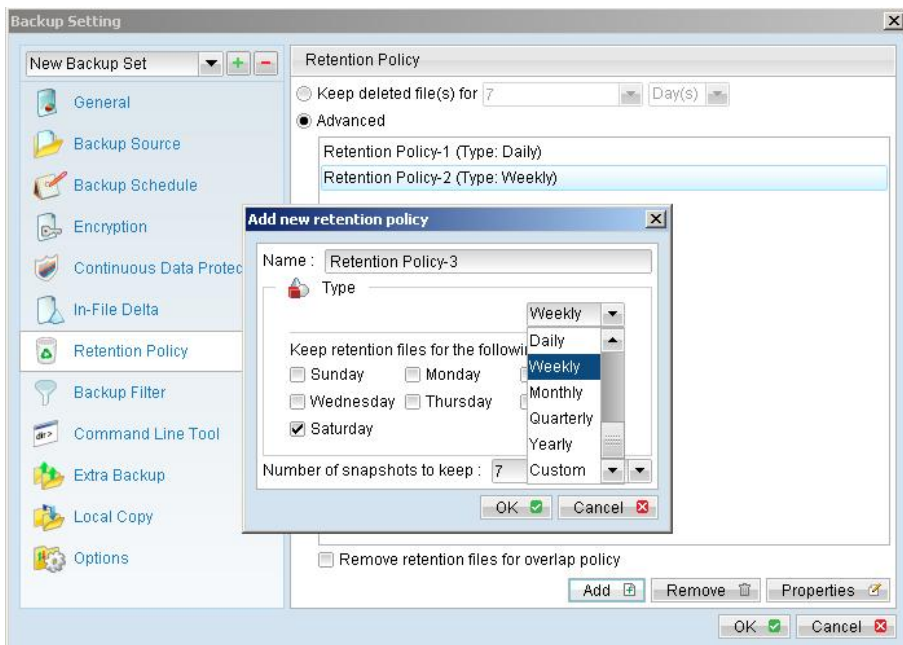

The [Advanced] retention policy allows you to configure a more flexible retention policy. It allows you to keep a set of snapshots of all backup files based on the time of the backup Jobs. For example, you can configure the advanced retention policy to keep the following sets of backup files to mimic the retention policy of the old days when you were still doing tape rotations:

- ◆ All files available within the last 7 days
- ◆ All files available on the last 4 Saturdays within the last 28 days
- ◆ All files available on the 1st day of each month within the last 3 months
- ◆ All files available on the 1st day of each quarter within the last 12 months
- ◆ All files available on the 1st day of each year within the last 7 years

To do so, you need to setup your advanced retention policy as follows:

- ◆ Type = Daily; Number of copy to keep = 7
- ◆ Type = Weekly; Frequency = Saturday; Number of copy to keep = 4
- ◆ Type = Monthly; Frequency = Day 1; Number of copy to keep = 3
- ◆ Type = Quarterly; Frequency = Day 1 of Jan, Apr, Jul, Oct; Number of copy to keep = 4
- ◆ Type = Yearly; Frequency = Date 01-01; Number of copy to keep = 7

Assuming today is 17-Jan-2006, if [Remove retention files for overlap policy] is NOT enabled, a total of 22 snapshots (provided you have run backups daily for more than 7 years) will be kept on the server accordingly, i.e.:

Daily	Weekly	Monthly	Quarterly	Yearly
16-Jan-2006	14-Jan-2006	01-Jan-2006	01-Jan-2006	01-Jan-2006
15-Jan-2006	07-Jan-2006	01-Dec-2005	01-Oct-2005	01-Jan-2005
14-Jan-2006	31-Dec-2005	01-Nov-2005	01-Jul-2005	01-Jan-2004
13-Jan-2006	24-Dec-2005		01-Apr-2005	01-Jan-2003
12-Jan-2006				01-Jan-2002
11-Jan-2006				01-Jan-2001
10-Jan-2006				01-Jan-2000

If [Remove retention files for overlap policy] is enabled, only the following snapshots are kept:

Daily	Weekly	Monthly	Quarterly	Yearly
16-Jan-2006	14-Jan-2006	01-Jan-2006	01-Jan-2006	01-Jan-2006
15-Jan-2006	07-Jan-2006	01-Dec-2005	01-Oct-2005	01-Jan-2005
14-Jan-2006	31-Dec-2005	01-Nov-2005	01-Jul-2005	01-Jan-2004
13-Jan-2006	24-Dec-2005		01-Apr-2005	01-Jan-2003
12-Jan-2006				01-Jan-2002
11-Jan-2006				01-Jan-2001
10-Jan-2006				01-Jan-2000

The weekly policy overrides the daily policy so the snapshots of 10-Jan-2006, 11-Jan-2006, 12-Jan-2006, 13-Jan-2006 and 14-Jan-2006 are removed. The monthly policy overrides the weekly policy so the snapshots of 24-Dec-2005 and 31-Dec-2005 are removed. The same applies to the monthly, quarterly and yearly policy giving a total of 11 snapshots.

5.14 Extra Backup (Off-Line backup, Logout Reminder)

Off-line backup is basically designed for notebook users who are off-line most of the time and cannot rely on the backup schedule to backup regularly. The "Backup Interval" allows notebook users to specify the interval that they would like their data to backup. When the machine is online and this interval has elapsed, backup will run automatically. If [Off-Line Backup Alert] is enabled, a popup message box will ask the user to confirm starting the backup.

The [Email Notification] setting is the number of days since the last backup that triggers the backup server to send email notification to the client to remind him to run an off-line backup.

When the [System Logout Backup Reminder] setting is enabled, a popup message box will ask the user to start a backup before logging out / shutting down Windows.

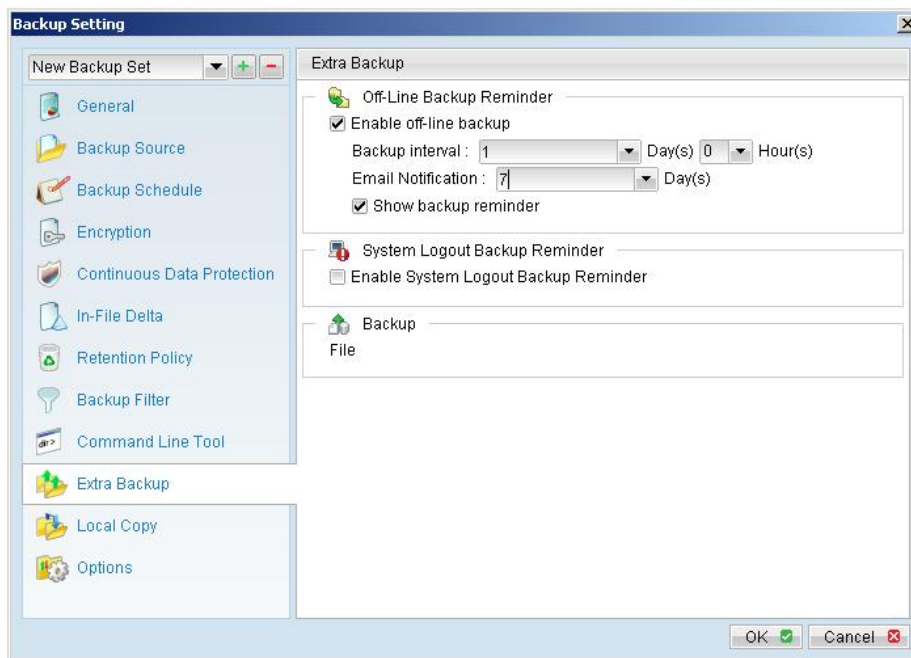

5.15 In-File Delta

Please refer to the [in-file delta section](#) for more information on this topic.

5.16 Local Copy (Not Available in Lite Client)

If you want to save an extra copy of backup data on your local hard disk (in addition to a copy of backup data stored on the backup server) to minimize file-restoring time and/or to provide an extra safety precaution, you can do the following:

- i. Open Vianet Backup Manager from the System Tray (see previous sections for details)
- ii. Setup your backup set (see previous sections for details)

- iii. Select [Local Copy] under your backup set from the left panel

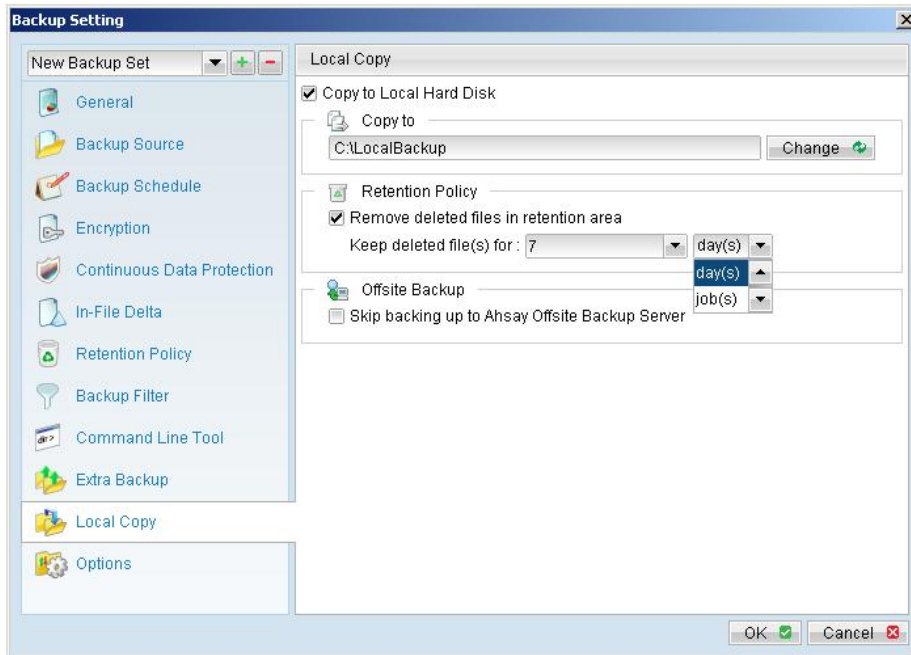

- iv. Check the [Copy to Local Hard Disk] checkbox
- v. Enter a directory to where you want an extra copy of your backup files to be stored in the [Copy to] field provided (preferably a directory under another hard disk)
- vi. An extra copy of backup will be saved in the [Copy to] directory when you run your backup job

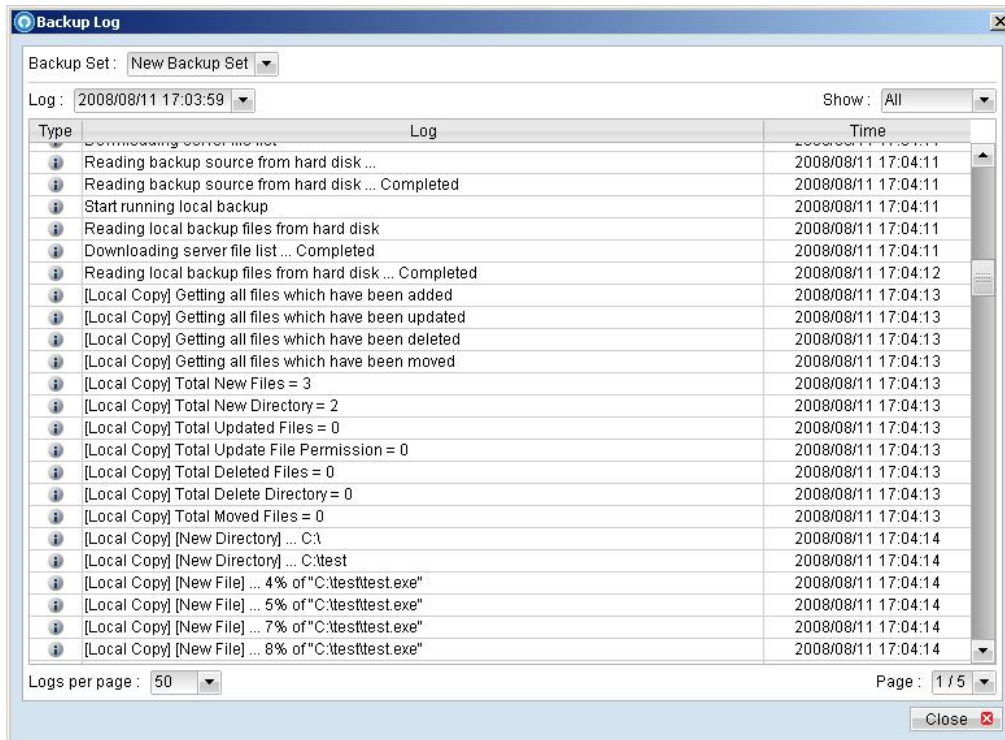

If you want to make local copy to a directory located on a NetWare server (or another computer is a windows workgroup) and you are getting "Network drive is not accessible" error message, please try adding the following command as a [Pre-backup command]

```
net use \\SERVER\SHARE [PASSWORD] /USER:[DOMAIN | MACHINE_NAME]\[USERNAME]
```

E.g.

```
C:\> net use \\Netware\Data password /USER:peter
C:\> net use \\WorkgroupComputer1\Data password /USER:WorkgroupComputer1\peter
```

This will authenticate the current process with the NetWare server (or another computer is a windows workgroup). Backup will then be allowed to run correctly.

How to restore "Local Copy" files

"Local Copy" files are stored in the [Copy to] directory (under [Local Copy] setting). To restore backup files, please do the followings:

- i. Press the button on the main page of Vianet Backup Manager dialog.
- ii. Select the required [Backup Set] from the list and press [Next] to proceed.
- iii. Fill in the [Source Directory] (directory where "Local Copy" files are stored) and [Destination Directory] (directory to where you want "Local Copy" files to be restored)

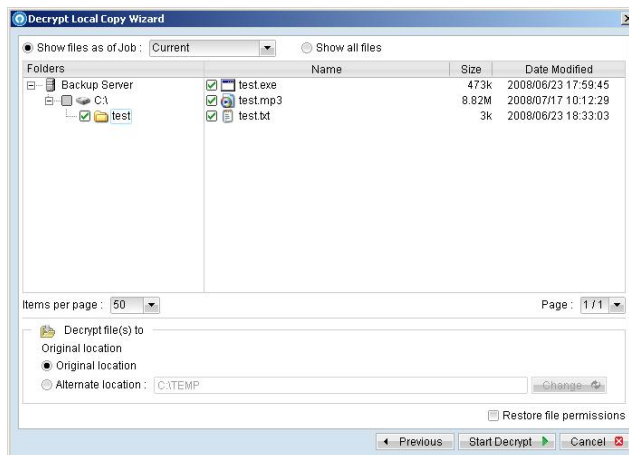

- iv. Click [Start Decrypt], and when it finishes you can see something similar to the following on the screen:

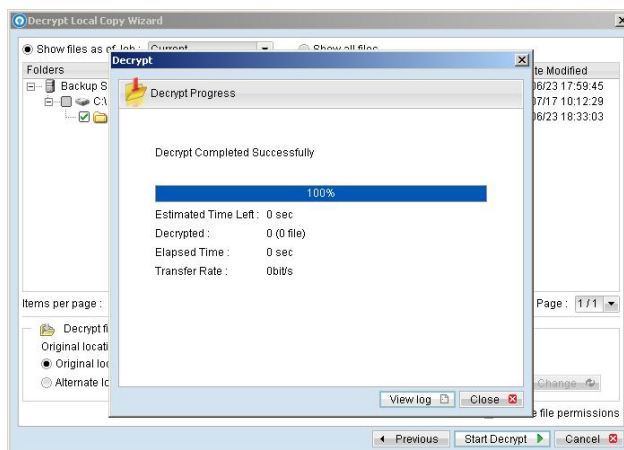

5.17 Using One Backup Account for Multiple Computers (Not Supported in Lite Client)

Vianet Backup Manager allows you to backup multiple computers using a single backup account. To backup multiple computers, you need to create a different backup set to backup each individual computer and to configure the [Run scheduled backup on this computer] checkbox, which is placed under the [Backup Schedule] node.

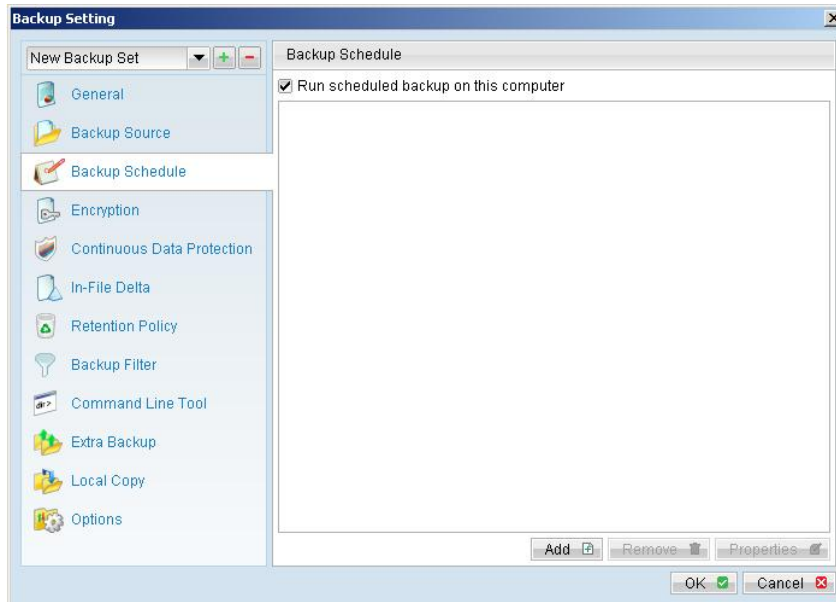

Since the computer that created the backup set will have its computer name associated with the backup set. The backup scheduler running on each computer will only run backup sets with the same computer name as itself. Thus, you just need to make sure that all your computer names using a single backup account are unique.

6 Backing Up Files

This chapter describes how files are backed up by Vianet Backup Manager to the backup server

6.1 How files are backed up

The diagram below describes how Vianet Backup Manager backup your files.

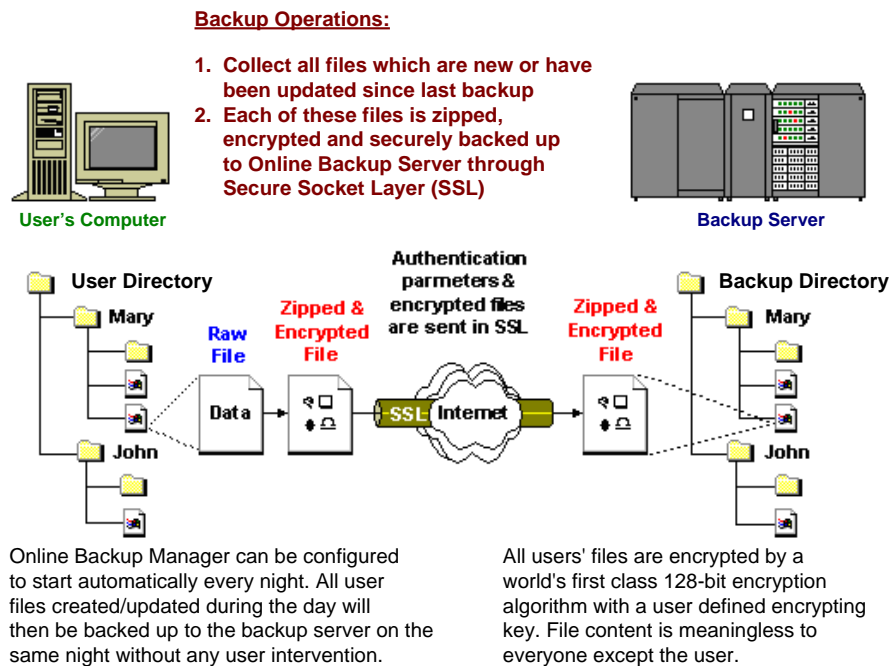

Run backup at scheduled time automatically

Once you set your backup scheduled, a backup job will be started automatically to perform backup operation for you at your absence. You can have backup running at your scheduled time as often as you want (e.g. twice a day or hourly during office hour) without requiring doing any extra work.

Incremental Backup

Unchanged files are already backed up to server and need not to be backed up again. Vianet Backup Manager will pick the new or updated files from your backup set files and upload only these files to the server. It significantly reduces the time required to perform the backup operation since most users update less than 5% of their total data each day.

Compress and encrypt data automatically



Data are compressed and encrypted before they are uploaded to the server. Not only does it reduce the storage space to keep you backup files, it also ensures the privacy of your data.

File Retention Policy

The built-in file retention policy allows you to access multiple versions of the same file or even deleted files from your backup set. Backup files are put into a retention area before they are removed from the server. If you want to get back a deleted file (or you want to get back the previous versions of an updated files) within the retention period, these files will always be available in the retention area. This feature is particularly useful when you have accidentally deleted a file or incorrectly updated a file within the file retention period (file retention period is user customizable).

6.2 Backup files directly to the backup server

You can backup your data to Vianet Online Backup by following instructions below.

- i. Open Vianet Backup Manager.
- ii. Right click Vianet Backup Manager icon available in the system tray and choose [Open].
 - a. To start setting up backup sets, click the  button to open the [Backup Setting] dialog.
 - b. On the left panel, press the  button to create a new backup set.
 - c. Enter a name for your backup set.

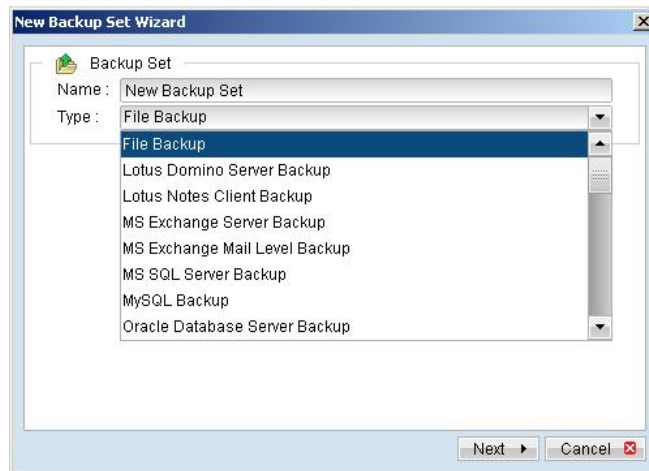

- d. Select the files/directories you want to backup.



Press [Advance] to add more files to the backup set.

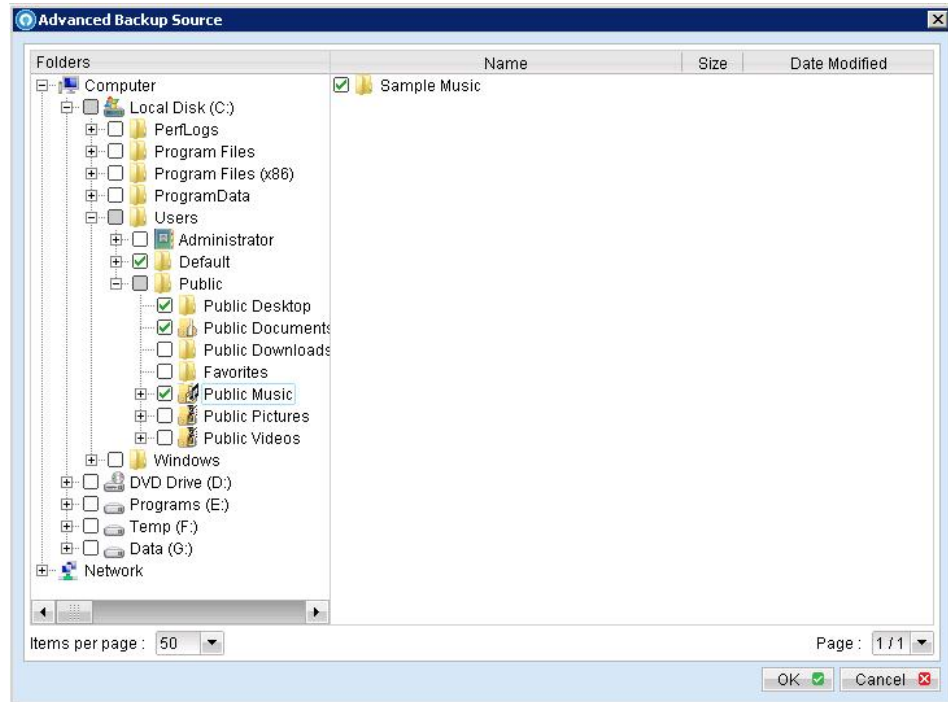

- e. Set the backup schedule (Note: You can have more than one schedule in a backup set).

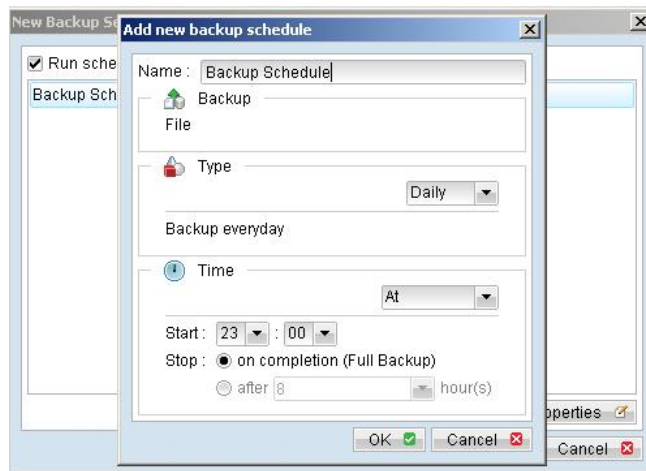

- iii. Run Backup
 - a. Press the [Backup] button on the main page of Vianet Backup Manager dialog.
 - b. Select the backup set you want to run and select [Offsite Backup Server] to start backing up your files to Vianet Online Backup. If applicable, you can change the In-File Delta Type also.

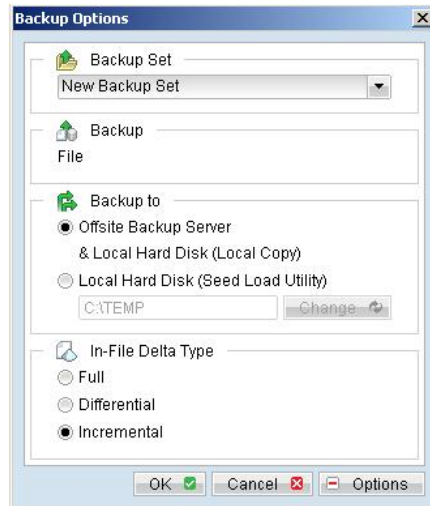

- c. Press [OK] to start the backup job.

Note:

1. You can have more than one backup set in a backup account.

6.3 Backup files to removable hard disk (seed loading) (Not Supported in Lite Client)

If you have a lot of data (e.g. 300GB) to backup to the backup server, it would take a considerable amount of time to perform the first full backup through the Internet. If you run into this problem, you can use the Seed Loading Utility to backup your backup set to local hard disk (instead of directly to the backup server) and then transport the backup data, using removable hard disk, to Vianet Online Backup. The administrator can then load all your backup files from your removable hard disk into your backup account. This could then save you days (even weeks) of performing your first full backup. Since subsequent backup will be incremental backup (only new or updated files will be uploaded to the server) you should have no problems uploading your backup data afterwards.

To perform seeding loading, please do the following:

- i. Open Vianet Backup Manager from the System Tray (see previous sections for details).
- ii. Setup your backup set (see previous sections for details).
- iii. Select the backup set you want to run and select [Local Hard Disk (Seed Load Utility)] to start backing up your files to local hard disk. In the field under the option, enter a directory where you want all backup files to be stored.

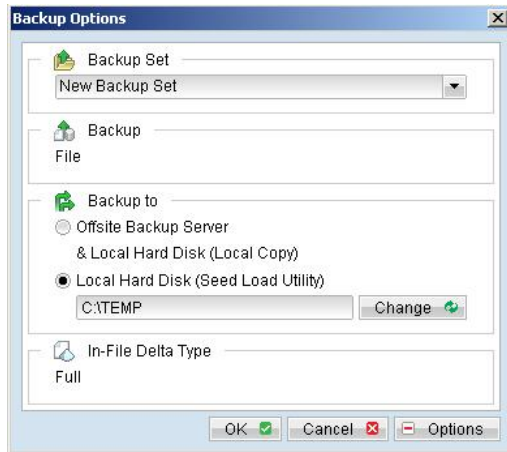

- iv. Please make sure you have enough free space in the directory specified. If you are going to transport a removable hard disk to Vianet Online Backup, please enter a directory under your removable hard disk here.

Press the [OK] button to start the backup job.

- v. You should get the message "Backup Completed Successfully" as shown below after all backup files are spooled to the directory you specified.

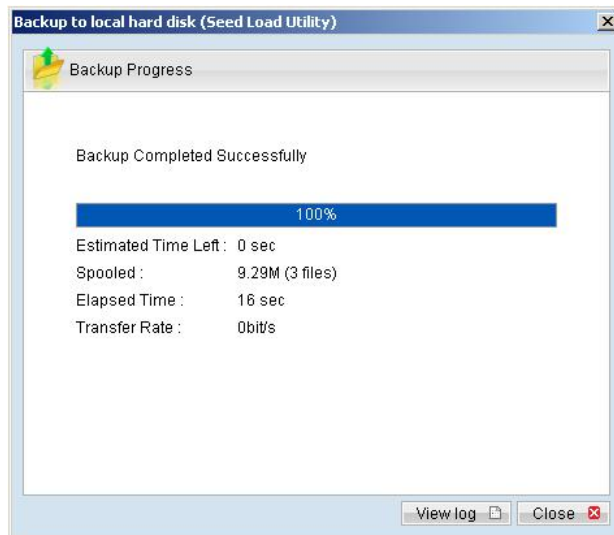

- vi. Transport the data in the specified directory to Vianet Online Backup.

7 Restoring Files

This chapter describes different ways files can be restored from the backup server

7.1 Restore backup files directly from backup server

You can use either Vianet Backup Manager or the web restorer to restore backup files from the backup server.

Using Vianet Backup Manager

You can restore your data from the backup server by following instructions below.

- i. Open Vianet Backup Manager from the System Tray (see previous sections for details).
- ii. Select the [Restore] button on the left of the main page of Vianet Backup Manager dialog.
- iii. Select the backup set from which you would like files to be restored from the list.
Note: This step is skipped in the Lite Client.

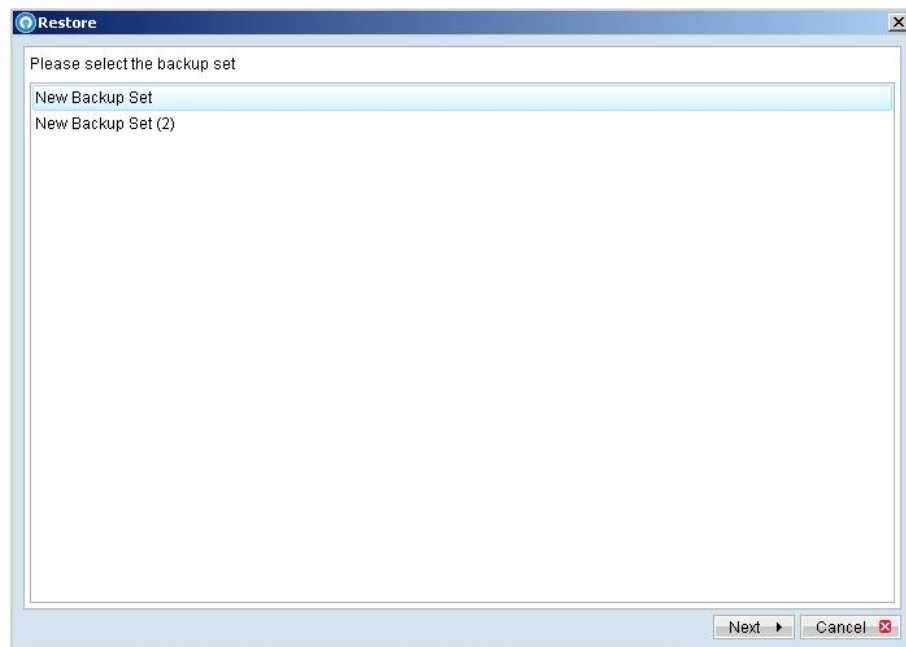

- iv. Select the snapshot of your backup files that you would like to restore from the backup server by using [Show files after Job] drop down list

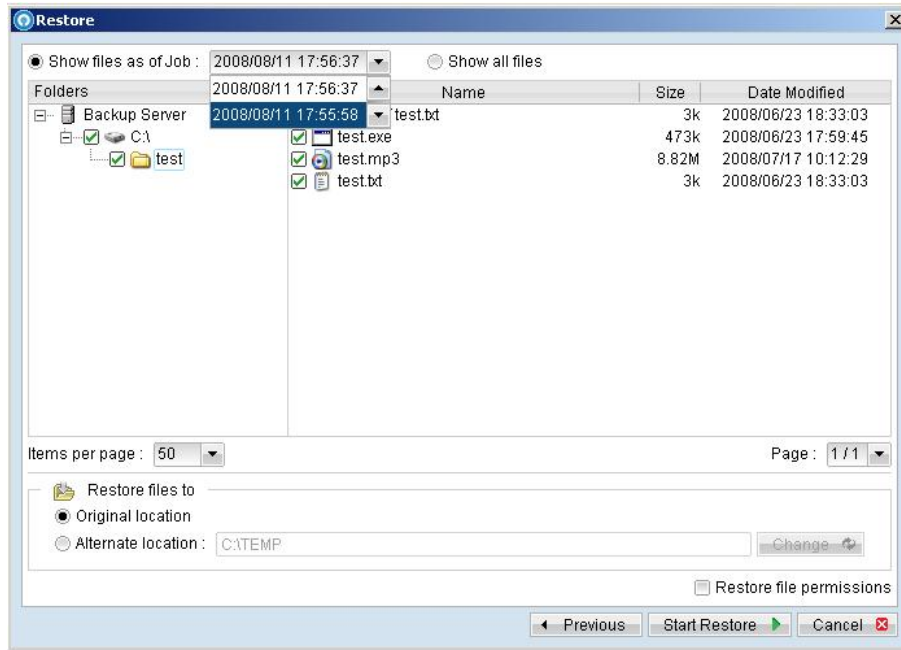

- v. Use the [Change] button to select the directory to where you want files to be restored (or simply select [Original location] to restore files to their original path).
- vi. Select the files that you would like to restore and press the [Start Restore] button to start.
- vii. Files will be restored automatically as shown below (a file won't be downloaded from the backup server again if an identical file exists on local path already).

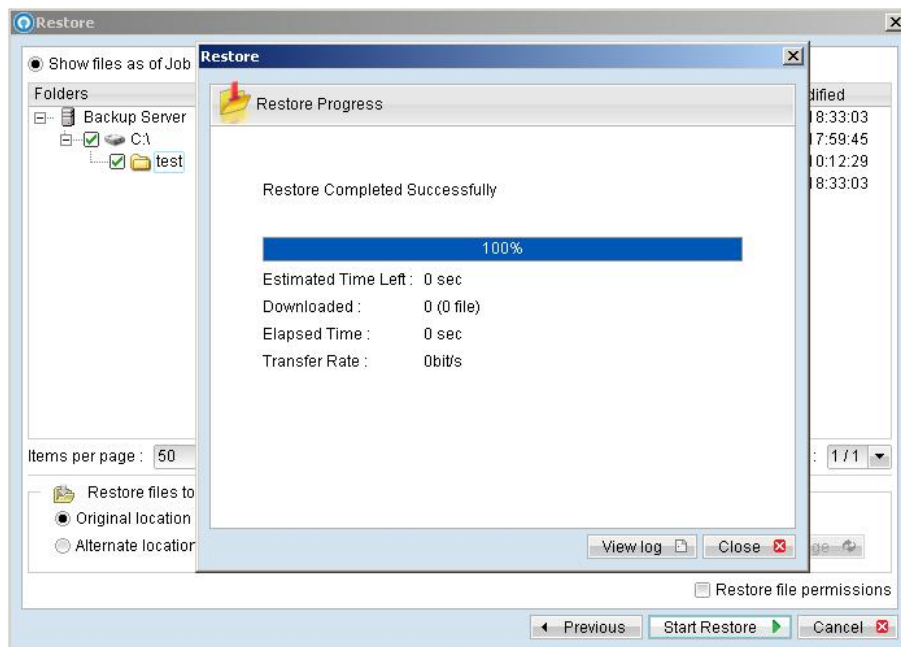

Using the web interface

You can restore your data from Vianet Online Backup by following instructions below.

- i. Logon to the Vianet Online Backup web interface

- ii. From the top menu, click [File Explorer]
- iii. Select the [Backup Set] that contains the files that you want to restore by clicking on the links
- iv. Select the snapshot of your backup files that you would like to restore from the backup server by using [Show files As Of] drop down list
- v. If you want to see all the different versions of all files (shown as gray below), just choose the [Show all files] radio button on the [File Explorer] page.

Files, which are shown in gray below (e.g. Copy of test.txt), are being stored in the retention area on the backup server but you can still restore these files from the backup server.

- vi. Select the files that you would like to restore and press the [Restore] button on the toolbar
- vii. A dialog shown below would appear
 - a. Press the [Restore] button
 - b. Enter the directory to which backup files should be restored to in the [Restore files to] textbox
 - c. Enter the encrypting key (your password) which will be used to decrypt your backup files upon restoring your backup files
 - d. Press the [Start] button to start restoring

7.2 Restore backup files from removable hard disk (Not Supported in Lite Client)

If you want to restore lots of backup files from the backup server and you find it too slow to restore all your backup files from the backup server through the internet. You can ask your backup services provider to send you all your backup files in removable hard disk (or CD/DVD). However, all backup files stored on backup server are in encrypted format. You need to decrypt them back to their original format before you can use them. To decrypt your backup files from removable media, please do the followings:

- i. Open Vianet Backup Manager from the System Tray
- ii. Press the  button to start the [Decrypt Files Wizard].
- iii. Use the [Change] button to locate the "files" directory (provided by your backup provider in removable hard disk or DVD) which contains the backup files that you want to decrypt



- iv. If you have more than one backup set under the "files" directory, select the [Backup Set] which contains the backup files that you want to decrypt

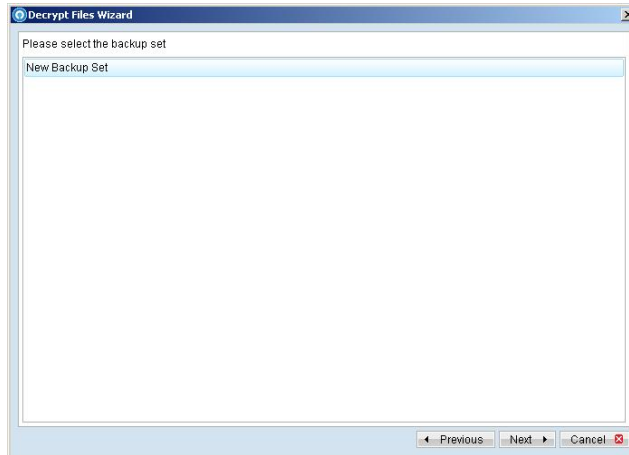

- v. Select the snapshot of your backup files that you would like to restore from the removable media by using [Show files after Job] drop down list

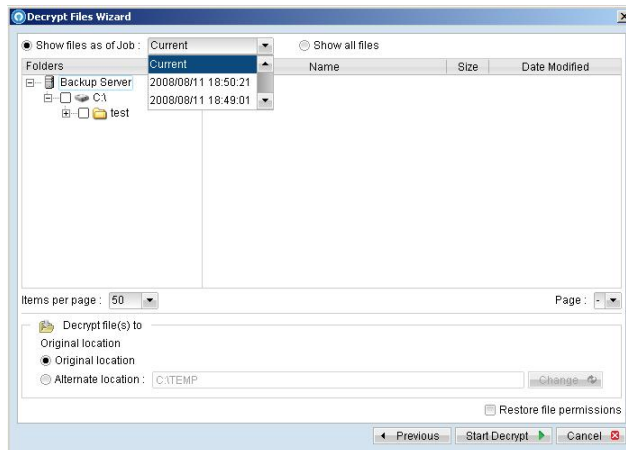

- vi. If you want to see all the different versions of all files (shown as gray below), just choose the [Show all files] radio button on the [Decrypt Files Wizard] dialog.

Files, which are shown in gray below (e.g. test.exe), are being stored in the retention area on the removable media (but you can still restore these files).

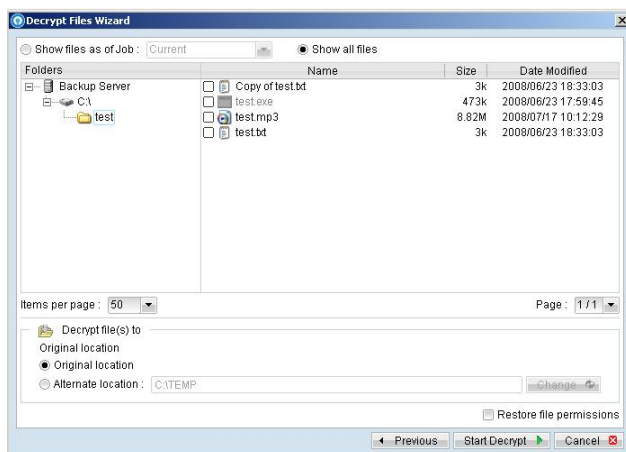

- vii. Use the [Change] button to select the directory to where you want files to be restored (or simply select [Original location] to restore files to their original path).
- viii. Press the [Start Decrypt] button to start restoring. When it finishes, you will see a screen similar to the following:

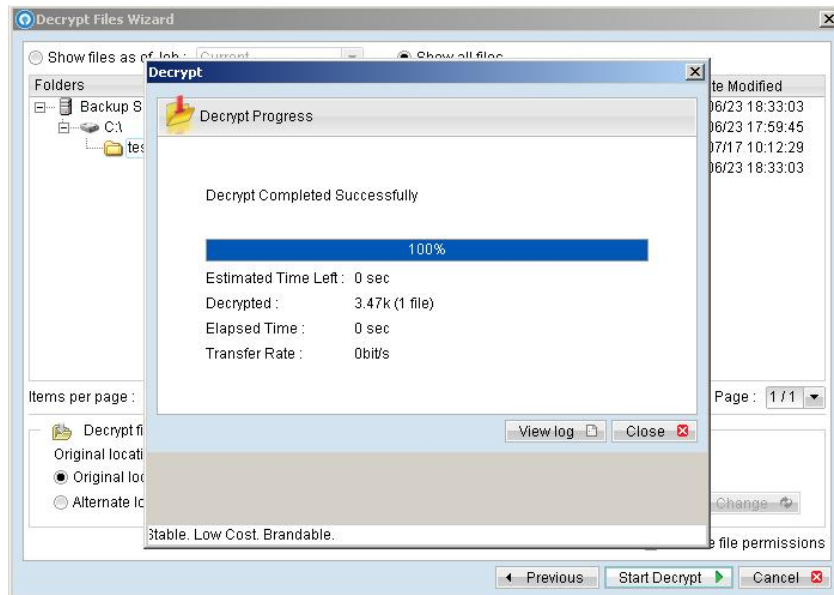

7.3 IP addresses Restriction for Online Restore

Online file restore operation can be restricted by IP addresses. You can ask to restrict online file restoration for your backup sets by IP addresses to only allow people from authorized IP addresses to restore files from the backup server. To check if online file restore of any backup set is restricted this way, please logon to the web interface of Vianet Online Backup, and check the section of [Backup Set] -> [Online Restore IP restriction].

Users are not allowed to update the [Online Restore IP restriction] directly. Please [contact support](#) to make these changes.

8 In-File Delta Technology

The chapter describes what in-file delta technology is and how in-file delta can be used to backup large database files (e.g. a 10GB Outlook.pst file) without uploading the whole database file every day.

8.1 Overview

In-file delta technology is an advanced data block matching algorithm which has the intelligence to pick up changes (delta) of file content between two files. Using this algorithm, daily backing up of large files (e.g. a 10GB Outlook.pst file) over low-speed internet connection is made possible because it requires only the changes of information (should be marginal) since the last backup to be sent over a low-speed internet connection to complete the backup of a large file (here we assume that the full backup of the file has been saved on the backup server already).

This is what will happen in the backup of a 10GB Outlook.pst file when it is backed up by Vianet Backup Manager with in-file delta technology.

- i. The whole files (10GB), along with its checksum file, are backed up to the backup server. This can be done directly through the internet or indirectly using the [seed loading utility](#) on a removable hard disk.
- ii. When backup runs again later (normally the next day), Vianet Backup Manager will download a checksum listing of all data blocks of the full backup file (or last incremental backup file) from the backup server and use it to pick up all changes that have been made to the current Outlook.pst file.
- iii. Changes detected are then saved in a delta file which is uploaded to the backup server. A new checksum file is generated and is also uploaded. (This delta file is assumed to be small because the content of PST files doesn't change a lot during daily usage)
- iv. Subsequent backups of this 10GB Outlook.pst file will go through step ii and step iii again. As explained, only a small delta file and checksum file will be uploaded to the backup server.
- v. With in-file delta technology, daily backing up of large file over low-speed internet connection is now possible

Incremental in-file delta type

Incremental Delta will facilitate ease of backup. The delta is generated by comparing with the latest uploaded full or delta file. The delta file generated is the smallest possible and uses the least bandwidth during backup. For restoration, the full file and all delta files up to the required point-in-time is required to restore the file to a specific point-in-time.

Example: If you are adding around 100MB changes to a 10G Outlook.pst everyday.

After the first full backup job, Vianet Backup Manager will continue to generate and upload delta files instead of uploading the full file until either one of the following two rules are true:

- a) Number of deltas generated since the last full backup is greater than the [No. of Delta] setting.
- b) The delta ratio (the ratio of the delta file size against the full file size) is greater than the [Delta Ratio] setting

Using incremental delta, the delta generated by comparing the current file with the latest uploaded full or delta file is around 100MB.

Since the delta file size is around 100MB daily, the delta ratio (around 1%) will not trigger a full file upload. Instead Vianet Backup Manager will continue to generate and upload delta files until day 102 (assuming the full file was uploaded on day 1) when the number of deltas generated exceeds the [No. of Delta] setting and triggers the upload of the full Outlook.pst file. You can disable the [No. of Delta] and [Delta Ratio] if you don't want to upload the full file.

All delta files are generated with respect to changes made since the last incremental or full backup. This means that the last full backup file and **ALL** incremental delta backup files are required to restore the latest snapshot of a

backup file.

Differential in-file delta type

Differential Delta will facilitate ease of restore. The delta is generated by comparing with the latest uploaded full file. The delta file generated grows daily and uses more bandwidth during backup. For restoration, the full file and a single delta file is required to restore the file to a specific point-in-time.

Example: If you are adding around 100MB changes to a 10G Outlook.pst everyday.

After the first full backup job, Vianet Backup Manager will continue to generate and upload delta files instead of uploading the full file until either one of the following two rules are true:

- c) Number of deltas generated since the last full backup is greater than the [No. of Delta] setting.
- d) The delta ratio (the ratio of the delta file size against the full file size) is greater than the [Delta Ratio] setting

Using differential delta, the delta generated by comparing the current file with the latest uploaded full file is around 100MB for the 1st delta, 200MB for the 2nd delta, 300MB for the 3rd delta and so on.

Since the delta file grows by 100MB daily, the delta ratio for day 52 (delta file size is approximately 51x100= 5.1GB, assuming the full file was uploaded on day 1) being over 50% exceeds the [Delta Ratio] setting and triggers the upload of the full Outlook.pst file. You can disable the [No. of Delta] and [Delta Ratio] if you don't want to upload the full file.

All delta files are generated with respect to changes made since the last full backup file (i.e. differential backup). This means that only last full backup file and the last delta file are required to restore the latest snapshot of a backup file. This means that other intermediate delta files are only required if you want to restore other snapshots of a backup file.

Differential in-file delta backup has the benefits that a corrupted delta file would only make one particular version of a backup file non-recoverable and all other backups created by other delta files of the same file would still be intact.

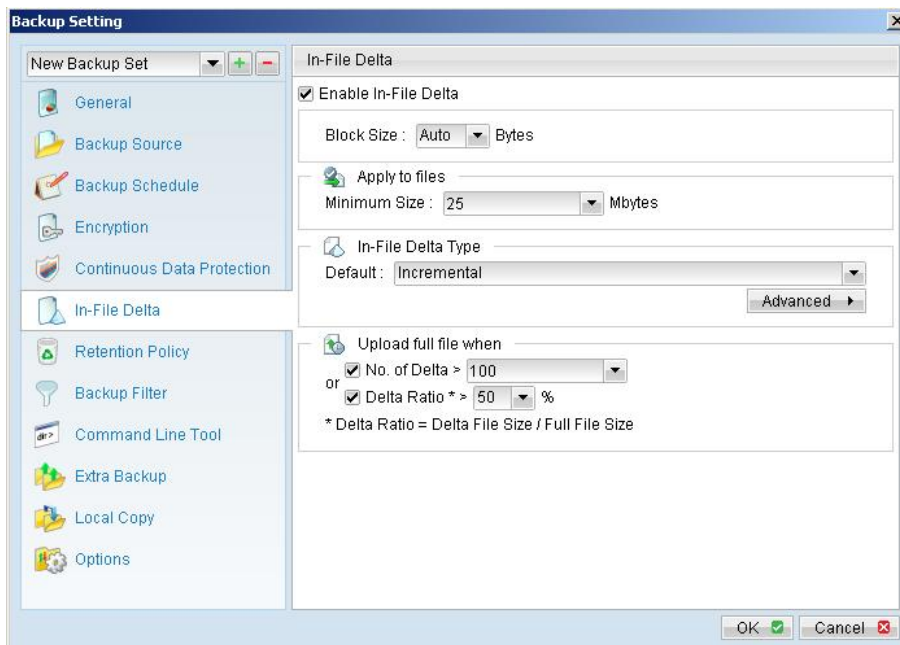

8.2 Block Size

The block size defines the size of data block being used to detect the changes between the last full or delta backup file and the file sitting on the local computer right now. In general, the smaller the block size, the more likely a matched data block can be found between the last backup file and the file on local computer. It, therefore, produces a smaller delta file but it would require more processing power to detect these changes. On the other hand, in-file delta backup running with larger block size will run faster but this will generally produce a larger delta file.

In most case, the default setting [Auto] will choose the optimal block size for each file (depending on the size of the file) for you.

8.3 Minimum File Size

The [Minimum Size] setting defines the smallest file size a file must have before the use and application of in-file delta backup technology.

If the size of a file that is being backed up is smaller than the [Minimum Size] setting, in-file delta backup technology won't be applied to this file and the whole file, instead of just the delta file, will be uploaded to the backup server. It is not necessary to perform in-file delta backup on small files because backing up the whole file doesn't take too long anyway. Backing up the whole file instead reduces the time required to restore a backup file.

8.4 Uploading full file again

No. of Delta

The [No. of delta] setting defines the maximum number of delta files from the same full backup file to be generated and backed up to the backup server before a full backup (the whole file) of this file is uploaded to the backup server instead.

For example, if you have created 100 delta files from the full backup file already and the [No. of delta] setting is set to 100, the next backup will upload a full backup file (the whole file) instead of just the delta file. However, if the [No. of delta] rule is disabled, it will keep generating delta files and uploading these delta files to the backup server until the other delta rule forces a full backup (i.e. delta ratio exceeded). This setting is here to make sure that there will always be a full backup file after a certain number of delta files have been generated.

Delta Ratio

The [Delta Ratio] setting is defined to be the size of a delta file divided by the size of its full backup files (i.e. the percentage of changes detected between the last full backup file and the current file).

If the delta ratio calculated from the size of the generated delta file and the size of the full backup file is greater than the [Delta Ratio] setting, the whole file, instead of just the delta file, will be backed up to the backup server. It is done this way because the difference between backing up the whole file and the delta file is not significant and it is better to upload the whole file instead to reduce the time required to restore the file.

The default setting of [Delta Ratio] is 50%. This means that if a file changes by more than 50%, the whole file, instead of just the delta file, will be backed up and uploaded to the backup server.

8.5 Advanced In-file delta type

The [In-file delta] -> [Advanced] setting allows users to override default in-file delta type when on a certain number of days (e.g. all Sundays or the 1st day of each month). This is useful if you want all in-file delta backups to be incremental but you want to do a differential in-file delta backup on Saturdays as well as the full file backups on the 1st day of every month. If you want to do this, simply press the [Advanced] button and the [Advanced In-File Delta Type Setting] dialog will be popped up as shown below.

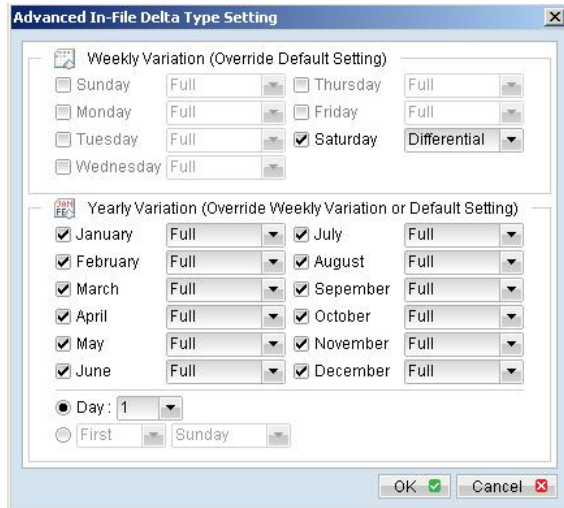

With this setting, all backup Jobs on Saturdays will be differential in-file delta backups, backups for the 1st day of each month will run a full backup. This ensures that all backup files will be backed up in full at a regular interval. One benefit of this is that restore time will run faster because of less delta merging. Another benefit is that the risk of a corrupted incremental delta file resulting in data loss is much lower because a full backup is always available periodically.

9 Backup/Restore Oracle 8i/9i/10g

This chapter will describe in details how Vianet Backup Manager will backup your Oracle Database Server and how you can restore an Oracle database using the backup files.

9.1 Requirements

- i. Vianet Backup Manager must be installed onto the computer that can connect to your Oracle Database Server using TCP/IP protocol.
- ii. Data from Oracle database will be backed up to a temporary directory before they are sent to Vianet Online Backup. Please make sure you have sufficient space on your computer to store these data when you run the backup job.
- iii. Database must be in archived log mode

To switch database to archived log mode, please do the following:

- a. Set the parameters below in the PFILE to enable automatic archiving

```
LOG_ARCHIVE_DEST = [directory where archive redo logs will be stored]
LOG_ARCHIVE_FORMAT = 'log%t_%s_%r.arc'
LOG_ARCHIVE_START = TRUE
```
- b. Set ORACLE_SID to your database's System Identifier (SID)

```
export ORACLE_SID=GDB1
```

 (assuming your database's SID is *GDB1*)
- c. Run SQL Plus and connect to database as SYSDBA

For Oracle 9i/10g

```
sqlplus "/ as sysdba"
```

For Oracle 8i

```
connect internal;
```
- d. Shutdown database

```
shutdown immediate
```
- e. Start and mount database

```
startup mount
```
- f. Switch database to archived log mode

```
alter database archivelog;
```
- g. Open database

```
alter database open;
```

Oracle 10g Example:
<pre>\$ export ORACLE_SID=GDB1 \$ sqlplus "/ as sysdba" SQL*Plus: Release 10.2.0.1.0 - Production on Thu Nov 8 15:08:57 2007 Copyright (c) 1982, 2005, Oracle. All rights reserved. Connected to: Oracle Database 10g Enterprise Edition Release 10.2.0.1.0 - Production With the Partitioning, OLAP and Data Mining options SQL> shutdown immediate Database closed. Database dismounted. ORACLE instance shut down.</pre>

```
SQL> startup mount
ORACLE instance started.

Total System Global Area 285212672 bytes
Fixed Size 1218992 bytes
Variable Size 96470608 bytes
Database Buffers 184549376 bytes
Redo Buffers 2973696 bytes
Database mounted.

SQL> alter database archivelog;

Database altered.

SQL> alter database open;

Database altered.
```

- iv. JAVASYSPRIV role is granted to system account

You can grant this role to system account by executing:

- h. Grant permission to system account

For Oracle 9i/10g

```
SQL> grant javasyspriv to system;
```

For Oracle 8i

```
SVRMGRL> connect internal

SVRMGRL> @?/javavm/install/initjvm.sql;

SVRMGRL> @?/rdbms/admin/catalog.sql;

SVRMGRL> @?/rdbms/admin/catproc.sql;

SVRMGRL> @?/javavm/install/initdbj.sql;

SQL> grant javasyspriv to system;
```

Oracle 9i/10g Example:

```
SQL> grant javasyspriv to system;

Grant succeeded.
```

9.2 Overview

Vianet Backup Manager will backup your Oracle database by taking the following steps.

- i. Connect to the Oracle database using SQL*NET over TCP/IP
- ii. Run all Pre-Commands of this backup set
- iii. If the backup type to run is [Database Backup type],
 - a. all data files in each of the table space(s) selected are copied to the temporary directory specified by this backup set
 - b. if there are temporary files in the database, the script to re-create the temporary files are generated to a file located in the temporary directory specified by this backup set
 - c. all non-default initialization parameters will be spooled to an initializing file located in the temporary directory specified by this backup set
 - d. all control files will be copied to the temporary directory specified by this backup set
 - e. all archived log files will be copied to the temporary directory specified by this backup set
- iv. If the backup type to run is [Archived Log Backup type],

- a. all archived log files will be copied to the temporary directory specified by this backup set
- v. Run all Post-Commands of this backup set
- vi. Upload all files copied to the temporary directory to Vianet Online Backup
- vii. Remove temporary files from the temporary directory

Note:

If your Oracle database is running on Windows, please install Vianet Backup Manager onto the company running the Oracle database if Vianet Backup Manager is to backup this Oracle database. This would shorten the time required to backup the Oracle database.

9.3 How to backup an Oracle Database (Physical Backup)

Please follow the instructions below to backup your Oracle database to Vianet Online Backup.

- i. Install Vianet Backup Manager onto your computer.
- ii. Open Vianet Backup Manager.

Right click Vianet Backup Manager icon available in the system tray and choose [Open].

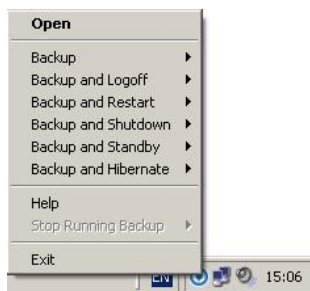

- iii. Create a backup set.
 - a. To start setting up backup sets, click the  button to open the [Backup Setting] dialog.
 - b. On the left panel, press the  button to create a new backup set.
 - c. On the dialog, choose [Oracle Database Server Backup] as the [Type].

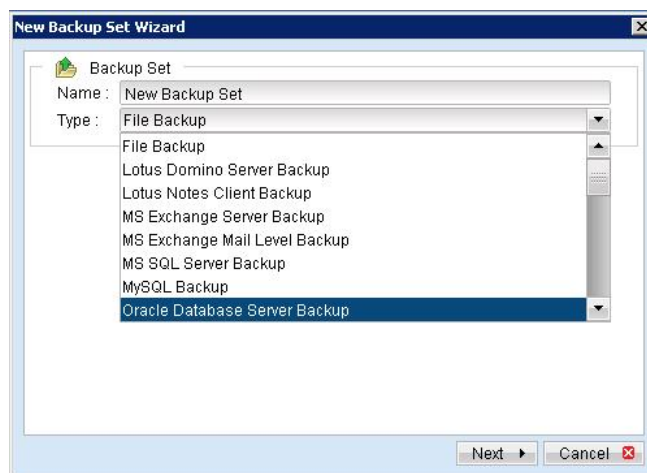

- d. Enter a name for your backup set.

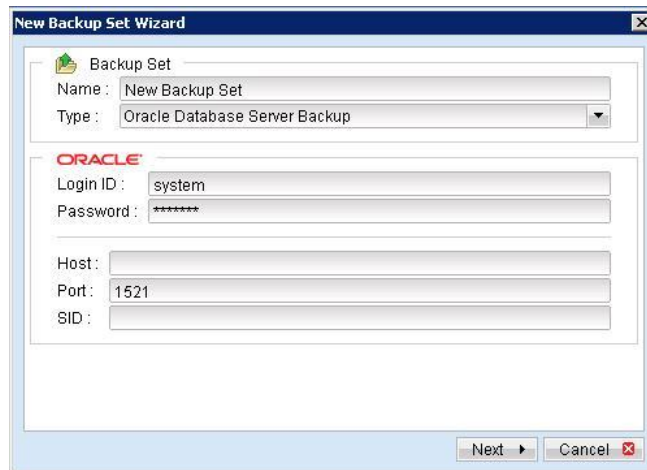

- e. Enter the system password, the Oracle Database Server Host Name, TNS Port and SID.
- f. Select the table space(s) you want to backup.

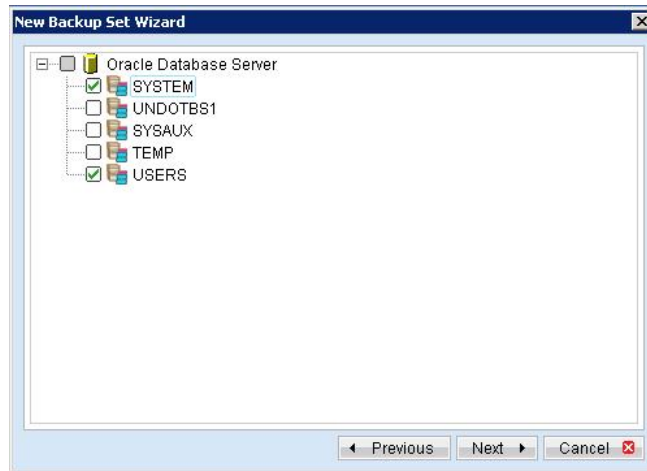

- g. Set the backup schedule for database backup and archived log backup.

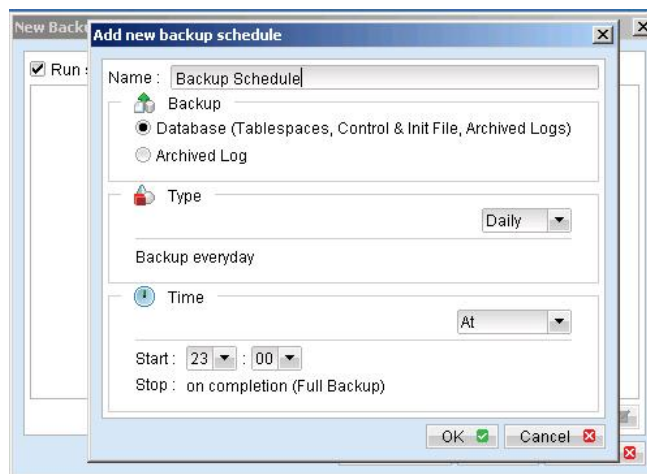

Note: You can have more than one schedule in a backup set, i.e. you can perform intra-day transaction log backup by adding more than one daily transaction log backup schedule to your backup set.

- h. Set the encryption algorithm, encryption mode and encrypting key for this backup set.



Hint: For maximum security, please select AES (Advanced Encryption Standard) Algorithm, CBC (Cipher Block Chaining) mode and use an encrypting key with more than 8 characters.

- iv. Run Backup.
 - a. Press the [Backup] button on the main page of Vianet Backup Manager dialog.
 - b. Select the backup type (e.g. Database Backup, Archived Log Backup) you would like to perform. Select the backup set you want to run and select [Offsite Backup Server] to start backing up your files to Vianet Online Backup. If applicable, you can change the In-File Delta Type also.

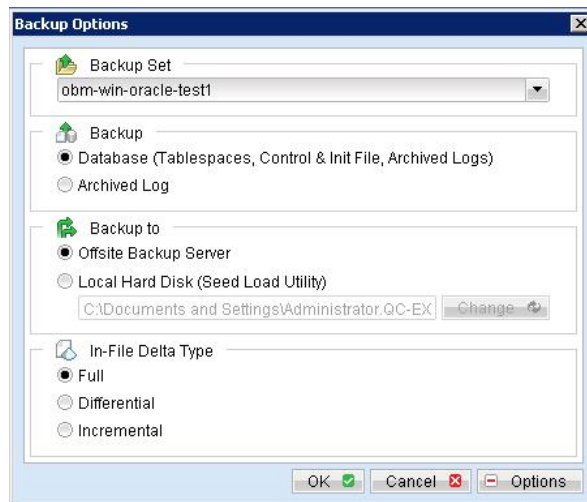

- c. Click [OK] to start backing up your files to Vianet Online Backup.
- d. When the backup finished, you should see **Backup Completed Successfully** as below.

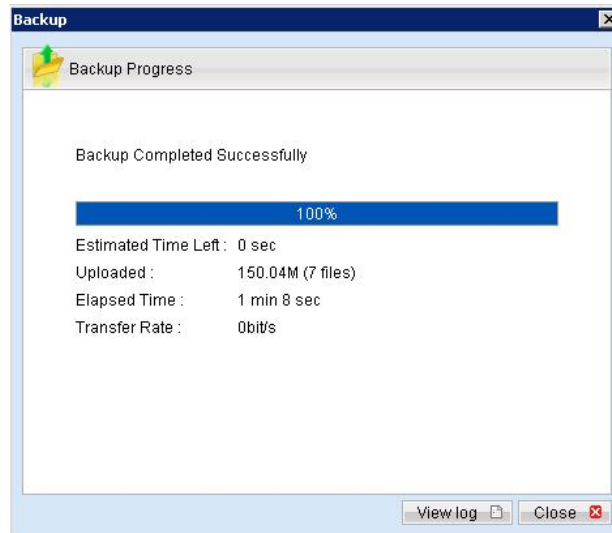

9.4 How to restore an Oracle Database

Please follow the instructions below to restore your Oracle 9i/10g databases from Vianet Online Backup.

- i. Download the backup files from Vianet Online Backup.

Please refer to the [Quick Start - Backup File] section for information on how to download backup files from Vianet Online Backup.

- ii. For restore an existing database

Shutdown the database

To shutdown the database, please do the following:

- a. Set ORACLE_SID to your database's System Identifier (SID)

```
$ export ORACLE_SID=GDB1 (assuming your database's SID is GDB1)
```

- b. Run SQL Plus and connect to database as SYSDBA

```
$ sqlplus "/ as sysdba"
```

- c. Shutdown database

```
SQL> shutdown immediate
```

```
Oracle 9i/10g Example:

$ export ORACLE_SID=GDB1

$ sqlplus "/ as sysdba"

SQL*Plus: Release 10.2.0.1.0 - Production on Thu Nov 8 17:04:57 2007
Copyright (c) 1982, 2005, Oracle. All rights reserved.

Connected to:
Oracle Database 10g Enterprise Edition Release 10.2.0.1.0 - Production
With the Partitioning, OLAP and Data Mining options

SQL> shutdown immediate
Database closed.
Database dismounted.
ORACLE instance shut down.
```

For recover a database that currently does not exist

Create a password file

```
$ orapwd file=$ORACLE_HOME/dbs/orapwGDB1 password=pwd123
(assuming your database's SID is GDB1, and password is pwd123)
```

Oracle 9i/10g Example:
\$ orapwd file=/oracle/OraHome1/dbs/orapwGDB1 password=pwd123

iii. Put all downloaded backup files in place

Control files, data files and archived logs are stored on Vianet Online Backup along with their full path information. You just need to put all these files back to their original locations when performing a database restore.

For example:

```
/obm_restore/Oracle Database Server/oracle/product/10.2.0/db_1/admin/GDB1/
/obm_restore/Oracle Database Server/oracle/product/10.2.0/db_1/dbs/initGDB1.ora
/obm_restore/Oracle Database Server/oracle/product/10.2.0/db_1/dbs/spfileGDB1.ora
/obm_restore/Oracle Database Server/oracle/product/10.2.0/db_1/flash_recovery_area/GDB1/
/obm_restore/Oracle Database Server/oracle/product/10.2.0/db_1/oradata/GDB1/
```

Move to

```
/oracle/product/10.2.0/db_1/admin/GDB1/
/oracle/product/10.2.0/db_1/dbs/initGDB1.ora
/oracle/product/10.2.0/db_1/dbs/spfileGDB1.ora
/oracle/product/10.2.0/db_1/flash_recovery_area/GDB1/
/oracle/product/10.2.0/db_1/oradata/GDB1/
```

iv. Rename database files (**Only for restoring database to a new location**)

Rename your database files by doing the following:

a. Modify the PFILE to update file path

Open the PFILE (`$ORACLE_HOME/dbs/initGDB1.ora`), change every file path to the new location, and then save it

For example:

```
background_dump_dest = /oracle/OraHome1/admin/GDB2/bdump
control_files = (/oracle/OraHome1/oradata/GDB2/control01.ct1,
                /oracle/OraHome1/oradata/GDB2/control02.ct1,
                /oracle/OraHome1/oradata/GDB2/control03.ct1)
core_dump_dest = /oracle/OraHome1/admin/GDB2/cdump
user_dump_dest = /oracle/OraHome1/admin/GDB2/udump
```

Change to

```
background_dump_dest = /new_db_location/OraHome1/admin/GDB2/bdump
control_files = (/new_db_location/OraHome1/oradata/GDB2/control01.ct1,
                /new_db_location/OraHome1/oradata/GDB2/control02.ct1,
                /new_db_location/OraHome1/oradata/GDB2/control03.ct1)
core_dump_dest = /new_db_location/OraHome1/admin/GDB2/cdump
user_dump_dest = /new_db_location/OraHome1/admin/GDB2/udump
```

b. You may need to quote the values of dispatchers as a single argument.

Add double quotation marks

```
dispatchers = "(PROTOCOL=TCP) (SERVICE=GDB1XDB)"
```

- c. Delete the SPFILE

Delete the SPFILE (`$ORACLE_HOME/dbs/spfileGDB1.ora`)

- d. Set ORACLE_SID to your database's System Identifier (SID)

`$ export ORACLE_SID=GDB1` (assuming your database's SID is `GDB1`)

- e. Run SQL Plus and connect to database as SYSDBA

`$ sqlplus "/ as sysdba"`

- f. Start and mount database

`SQL> startup mount`

- g. Create a backup of the control file to trace file

`SQL> alter database backup controlfile to trace as '/New_DB_Location/control.trc' reuse;` (assuming you create a trace file to `/New_DB_Location/`)

- h. Rename each of data file, log file and tempfile

Open the trace file that just created, and then check for the filename of each datafile, log file and tempfile.

Please do the following to rename each of the files:

`SQL> ALTER DATABASE RENAME FILE 'xxx' TO 'yyy';`
where `xxx` is the old filename found in the trace file, and `yyy` is the new filename with updated path

For example:

```
SQL> ALTER DATABASE RENAME FILE '/oracle/product/10.2.0/db_1/oradata/GDB1/system01.dbf' TO
'/new_db_location/oradata/GDB1/system01.dbf';

SQL> ALTER DATABASE RENAME FILE '/oracle/product/10.2.0/db_1/oradata/GDB1/undotbs01.dbf' TO
'/new_db_location/oradata/GDB1/undotbs01.dbf';

SQL> ALTER DATABASE RENAME FILE '/oracle/product/10.2.0/db_1/oradata/GDB1/sysaux01.dbf' TO
'/new_db_location/oradata/GDB1/sysaux01.dbf';

SQL> ALTER DATABASE RENAME FILE '/oracle/product/10.2.0/db_1/oradata/GDB1/users01.dbf' TO
'/new_db_location/oradata/GDB1/users01.dbf';

SQL> ALTER DATABASE RENAME FILE '/oracle/product/10.2.0/db_1/oradata/GDB1/TS1' TO
'/new_db_location/oradata/GDB1/TS1';

SQL> ALTER DATABASE RENAME FILE '/oracle/product/10.2.0/db_1/oradata/GDB1/redo01.log' TO
'/new_db_location/oradata/GDB1/redo01.log';

SQL> ALTER DATABASE RENAME FILE '/oracle/product/10.2.0/db_1/oradata/GDB1/redo02.log' TO
'/new_db_location/oradata/GDB1/redo02.log';

SQL> ALTER DATABASE RENAME FILE '/oracle/product/10.2.0/db_1/oradata/GDB1/redo03.log' TO
'/new_db_location/oradata/GDB1/redo03.log';

SQL> ALTER DATABASE RENAME FILE '/oracle/product/10.2.0/db_1/oradata/GDB1/temp01.dbf' TO
'/new_db_location/oradata/GDB1/temp01.dbf';
```

Oracle 9i/10g Example:

```
$ export ORACLE_SID=GDB1

$ sqlplus "/ as sysdba"

SQL*Plus: Release 10.2.0.1.0 - Production on Fri Nov 9 17:50:30 2007
Copyright (c) 1982, 2005, Oracle. All rights reserved.
Connected to an idle instance.

SQL> startup mount

ORACLE instance started.

Total System Global Area 285212672 bytes
Fixed Size 1218992 bytes
Variable Size 92276304 bytes
Database Buffers 188743680 bytes
Redo Buffers 2973696 bytes
Database mounted.

SQL> alter database backup controlfile to trace as '/new_db_location/control.trc' reuse;
```

```

Database altered.

SQL> ALTER DATABASE RENAME FILE '/oracle/product/10.2.0/db_1/oradata/GDB1/system01.dbf' TO
'/new_db_location/oradata/GDB1/system01.dbf';

Database altered.

SQL> ALTER DATABASE RENAME FILE '/oracle/product/10.2.0/db_1/oradata/GDB1/undotbs01.dbf' TO
'/new_db_location/oradata/GDB1/undotbs01.dbf';

Database altered.

SQL> ALTER DATABASE RENAME FILE '/oracle/product/10.2.0/db_1/oradata/GDB1/sysaux01.dbf' TO
'/new_db_location/oradata/GDB1/sysaux01.dbf';

Database altered.

SQL> ALTER DATABASE RENAME FILE '/oracle/product/10.2.0/db_1/oradata/GDB1/users01.dbf' TO
'/new_db_location/oradata/GDB1/users01.dbf';

Database altered.

SQL> ALTER DATABASE RENAME FILE '/oracle/product/10.2.0/db_1/oradata/GDB1/TS1' TO
'/new_db_location/oradata/GDB1/TS1';

Database altered.

SQL> ALTER DATABASE RENAME FILE '/oracle/product/10.2.0/db_1/oradata/GDB1/redo01.log' TO
'/new_db_location/oradata/GDB1/redo01.log';

Database altered.

SQL> ALTER DATABASE RENAME FILE '/oracle/product/10.2.0/db_1/oradata/GDB1/redo02.log' TO
'/new_db_location/oradata/GDB1/redo02.log';

Database altered.

SQL> ALTER DATABASE RENAME FILE '/oracle/product/10.2.0/db_1/oradata/GDB1/redo03.log' TO
'/new_db_location/oradata/GDB1/redo03.log';

Database altered.

SQL> ALTER DATABASE RENAME FILE '/oracle/product/10.2.0/db_1/oradata/GDB1/temp01.dbf' TO
'/new_db_location/oradata/GDB1/temp01.dbf';

Database altered.

```

v. Restore Database

Use Recovery Manager to restore your database by doing the following:

For Oracle 9i/10g

- a. Set ORACLE_SID to your database's System Identifier (SID)

```
$ export ORACLE_SID=GDB1 (assuming your database's SID is GDB1)
```

- b. Run Oracle Recovery Manager (rman) and connect to the target database

```
$ rman target /
```

- c. Start and mount database

```
RMAN> startup mount
```

- d. Reapply all transactions from the archived log files to the last sequence

```
RMAN> recover database until sequence=4 thread=1; (assuming the sequence number of your last
archived redo log is 3)
```

Sequence number are named on the filename of archived redo log

```
e.g. /oracle/OraHome1/dbs/ol_mf_1_2_3m5h1svs_.arc
/oracle/OraHome1/dbs/ol_mf_1_3_3m5h1yby_.arc
```

in this case, the sequence number of archived redo log is 4.

- e. Open database

```
RMAN> alter database open resetlogs;
```

Oracle 9i/10g Example:

```

$ export ORACLE_SID=GDB1
$ rman target /
Recovery Manager: Release 10.2.0.1.0 - Production on Thu Nov 8 17:46:27 2007
Copyright (c) 1982, 2005, Oracle. All rights reserved.
connected to target database (not started)
RMAN> startup mount
Oracle instance started
database mounted
Total System Global Area      285212672 bytes
Fixed Size                    1218992 bytes
Variable Size                 113247824 bytes
Database Buffers              167772160 bytes
Redo Buffers                   2973696 bytes
RMAN> recover database until sequence=4 thread=1;
Starting recover at 08-NOV-07
Starting implicit crosscheck backup at 08-NOV-07
using target database control file instead of recovery catalog
allocated channel: ORA_DISK_1
channel ORA_DISK_1: sid=157 devtype=DISK
Finished implicit crosscheck backup at 08-NOV-07
Starting implicit crosscheck copy at 08-NOV-07
using channel ORA_DISK_1
Finished implicit crosscheck copy at 08-NOV-07
searching for all files in the recovery area
cataloging files...
cataloging done
List of Cataloged Files
=====
File Name:
/oracle/product/10.2.0/db_1/flash_recovery_area/GDB1/archivelog/2007_11_08/o1_mf_1_3_3m5h1y
by_.arc
using channel ORA_DISK_1
starting media recovery
archive log thread 1 sequence 2 is already on disk as file
/oracle/product/10.2.0/db_1/flash_recovery_area/GDB1/archivelog/2007_11_08/o1_mf_1_2_3m5h1s
vs_.arc
archive log thread 1 sequence 3 is already on disk as file
/oracle/product/10.2.0/db_1/flash_recovery_area/GDB1/archivelog/2007_11_08/o1_mf_1_3_3m5h1y
by_.arc
archive log
filename=/oracle/product/10.2.0/db_1/flash_recovery_area/GDB1/archivelog/2007_11_08/o1_mf_1
_2_3m5h1svs_.arc thread=1 sequence=2
archive log
filename=/oracle/product/10.2.0/db_1/flash_recovery_area/GDB1/archivelog/2007_11_08/o1_mf_1
_3_3m5h1yby_.arc thread=1 sequence=3
media recovery complete, elapsed time: 00:00:01
Finished recover at 08-NOV-07
RMAN> alter database open resetlogs;
database opened

```

For Oracle 8i

- a. Set ORACLE_SID to your database's System Identifier (SID)

```
$ export ORACLE_SID=GDB1
```

 (assuming your database's SID is *GDB1*)
- b. Run Oracle Server Manager (svrmgrl)

```
$ svrmgrl
```
- c. Connect to the target database

```
SVRMGR> connect internal
```
- d. Start and mount database

```
SVRMGR> start mount;
```
- e. Reapply all transactions from the archived log files

```
RMAN> recover database using backup controlfile
```

f. Open database

```
RMAN> ALTER DATABASE OPEN RESETLOGS;
```

```

Oracle 8i Example:

$ svrmgrl
SVRMGR> connect internal

SVRMGR> startup mount;
ORACLE instance started.
Total System Global Area          95874448 bytes
Fixed Size                          64912 bytes
Variable Size                      52744192 bytes
Database Buffers                   40960000 bytes
Redo Buffers                        2105344 bytes
Database mounted.

SVRMGR> recover database using backup controlfile
ORA-00279: change 419671 generated at 06/14/03 02:51:49 needed for thread 1
ORA-00289: suggestion : /data/ora815/vin/archive/ARCH0000000225.LOG
ORA-00280: change 419671 for thread 1 is in sequence #225
ORA-00278: log file '/data/ora815/vin/archive/ARCH0000000224.LOG' no longer needed for this
recovery
Specify log: {<RET>=suggested | filename | AUTO | CANCEL}
AUTO
Log applied.
.
.
.
ORA-00279: change 547222 generated at 06/18/03 19:58:26 needed for thread 1
ORA-00289: suggestion : /data/ora815/vin/archive/ARCH0000000384.LOG
ORA-00280: change 547222 for thread 1 is in sequence #384
ORA-00278: log file '/data/ora815/vin/archive/ARCH0000000383.LOG' no longer needed for this
recovery
ORA-00308: cannot open archived log '/data/ora815/vin/archive/ARCH0000000384.LOG'
ORA-27037: unable to obtain file status
Linux Error: 2: No such file or directory
Additional information: 3

SVRMGR> recover database using backup controlfile until cancel
ORA-00279: change 547222 generated at 06/18/03 19:58:26 needed for thread 1
ORA-00289: suggestion : /data/ora815/vin/archive/ARCH0000000384.LOG
ORA-00280: change 547222 for thread 1 is in sequence #384
Specify log: {<RET>=suggested | filename | AUTO | CANCEL}
CANCEL
Media recovery cancelled.
SVRMGR> alter database open resetlogs;
Statement processed.

```

vi. (Optional) Create Net Service Name and Database Service Listener

To create Net Service Name

Start **Net Manager** by running the command **netmgr**

```
$ netmgr
```

- expand [Oracle Net Configuration]
- expand [Local]
- select [Service Naming]
- click "+" icon on the toolbar
- Net Service Name Wizard will be launched to guide you through creating a net service name
- click [File] on the menu bar
- [Save Network Configuration] on the menu bar

To create Database Service Listener

Start **Net Manager** by running the command **netmgr**

```
$ netmgr
```

- expand [Oracle Net Configuration]
- expand [Local]
- expand [Listeners]
- select [LISTENER]
- select [Database Services] from combo box
- click [Add Database]
- input Global Database Name and SID
- click [File] on the menu bar
- [Save Network Configuration] on the menu bar

9.5 How to restore a single table space

Restoring a table space required a backup of data files consistent with the existing archived logs and control files, as redo will be applied during the restore operation.

Please follow the instructions below to restore a table space from Vianet Online Backup.

- i. Download the backup files from Vianet Online Backup.

Please refer to the [Quick Start - Backup File] section for information on how to download backup files from Vianet Online Backup.

- ii. Set ORACLE_SID to your database's System Identifier (SID)

```
$ export ORACLE_SID=GDB1 (assuming your database's SID is GDB1)
```

- iii. Run SQL Plus and connect to database as SYSDBA

```
$ sqlplus "/ as sysdba"
```

- iv. Shutdown database

```
SQL> shutdown immediate
```

- v. Put the downloaded table space data files in place

Datafile names and paths can be found by using the REPORT SCHEMA command.

- a. Set ORACLE_SID to your database's System Identifier (SID)

```
$ export ORACLE_SID=GDB1 (assuming your database's SID is GDB1)
```

- b. Run Oracle Recovery Manager (rman) and connect to the target database

```
$ rman target /
```

- c. Start and mount database

```
RMAN> startup mount
```

- d. List the names of all data files and table spaces

```
RMAN> report schema;
```

For example:

```
Report of database schema
File K-bytes   Table space  RB segs  Datafile Name
-----
1      419840 SYSTEM      ***     /oracle/OraHome1/oradata/GDB1/system01.dbf
2      204800 UNDOTBS1  ***     /oracle/OraHome1/oradata/GDB1/undotbs01.dbf
3        20480 CWMLITE  ***     /oracle/OraHome1/oradata/GDB1/cwmlite01.dbf
4        20480 DRSYS     ***     /oracle/OraHome1/oradata/GDB1/drsys01.dbf
5     141440 EXAMPLE  ***     /oracle/OraHome1/oradata/GDB1/example01.dbf
6        25600 INDX     ***     /oracle/OraHome1/oradata/GDB1/indx01.dbf
7        20480 ODM       ***     /oracle/OraHome1/oradata/GDB1/odm01.dbf
8        10240 TOOLS     ***     /oracle/OraHome1/oradata/GDB1/tools01.dbf
9        25600 USERS     ***     /oracle/OraHome1/oradata/GDB1/users01.dbf
10       39040 XDB       ***     /oracle/OraHome1/oradata/GDB1/xdm01.dbf
11         0 TS1       ***     /oracle/OraHome1/oradata/GDB1/TS1_datafile1.dbf
12         0 TS1       ***     /oracle/OraHome1/oradata/GDB1/TS1_datafile2.dbf
13         0 TS1       ***     /oracle/OraHome1/oradata/GDB1/TS1_datafile3.dbf
```

- e. Put all the downloaded backup of datafile/s that constitute the table space to the listed location

For example:

/obm_restore/Oracle Database Server/oracle/OraHome1/oradata/GDB1/TS1_datafile1.dbf

/obm_restore/Oracle Database Server/oracle/OraHome1/oradata/GDB1/TS1_datafile2.dbf

/obm_restore/Oracle Database Server/oracle/OraHome1/oradata/GDB1/TS1_datafile3.dbf

Move to

/oracle/OraHome1/oradata/GDB1/TS1_datafile1.dbf

/oracle/OraHome1/oradata/GDB1/TS1_datafile2.dbf

/oracle/OraHome1/oradata/GDB1/TS1_datafile3.dbf

- vi. Restore table space

RMAN> recover table space TS1; (assuming your table space is TS1)

If your data files consistent with the database, you should see:

```

Oracle 9i/10g Example:

RMAN> recover table space TS1;

Starting recover at 19-JUL-07
allocated channel: ORA_DISK_1
channel ORA_DISK_1: sid=156 devtype=DISK

starting media recovery

archive log thread 1 sequence 1 is already on disk as file D:\ORACLE\PRODUCT\10.
2.0\FLASH_RECOVERY_AREA\GDB1\ARCHIVELOG\2007_07_19\01_MF_1_1_39Y98F0H_.ARC
archive log thread 1 sequence 2 is already on disk as file D:\ORACLE\PRODUCT\10.
2.0\FLASH_RECOVERY_AREA\GDB1\ARCHIVELOG\2007_07_19\01_MF_1_2_39Y98JSD_.ARC
archive log thread 1 sequence 3 is already on disk as file D:\ORACLE\PRODUCT\10.
2.0\FLASH_RECOVERY_AREA\GDB1\ARCHIVELOG\2007_07_19\01_MF_1_3_39Y9SW4D_.ARC
archive log filename=D:\ORACLE\PRODUCT\10.2.0\FLASH_RECOVERY_AREA\GDB1\ARCHIVELO
G\2007_07_19\01_MF_1_1_39Y98F0H_.ARC thread=1 sequence=1
media recovery complete, elapsed time: 00:00:01
Finished recover at 19-JUL-07
    
```

If your data files does not consistent with the database, you should see:

```

Oracle 9i/10g Example:

RMAN> recover table space TS1;

Starting recover at 19-JUL-07
allocated channel: ORA_DISK_1
channel ORA_DISK_1: sid=156 devtype=DISK
RMAN-00571: =====
RMAN-00569: ===== ERROR MESSAGE STACK FOLLOWS =====
RMAN-00571: =====
RMAN-03002: failure of recover command at 07/20/2007 12:24:49
RMAN-06163: some data files cannot be recovered, aborting the RECOVER command
RMAN-06166: datafile 7 cannot be recovered
RMAN-06166: datafile 6 cannot be recovered
RMAN-06166: datafile 5 cannot be recovered
    
```

In this case, you need to find the consistent data files in order to restore the table space.

If there are archive log missing, you should see:

```

Oracle 9i/10g Example:

RMAN> recover table space TS1;

Starting recover at 20-JUL-07
using channel ORA_DISK_1

starting media recovery
    
```



```
archive log thread 1 sequence 12 is already on disk as file D:\ORACLE\PRODUCT\10
.2.0\FLASH_RECOVERY_AREA\GDB1\ARCHIVELOG\2007_07_18\O1_MF_1_12_39VF4JNJ_.ARC
RMAN-00571: =====
RMAN-00569: ===== ERROR MESSAGE STACK FOLLOWS =====
RMAN-00571: =====
RMAN-03002: failure of recover command at 07/20/2007 12:28:52
RMAN-06053: unable to perform media recovery because of missing log
RMAN-06025: no backup of log thread 1 seq 13 lowscn 660617 found to restore
```

In this case, you need to find the missing archive log files in order to restore the table space.

vii. Open database

```
RMAN> alter database open;
```

```
Oracle 9i/10g Example:

$ export ORACLE_SID=GDB1

$ rman target /

Recovery Manager: Release 9.2.0.1.0 - Production
Copyright (c) 1995, 2002, Oracle Corporation. All rights reserved.

connected to target database (not started)

RMAN> startup mount

Oracle instance started
database mounted

Total System Global Area      235999352 bytes
Fixed Size                    450680 bytes
Variable Size                 201326592 bytes
Database Buffers              33554432 bytes
Redo Buffers                   667648 bytes

RMAN> report schema;

using target database control file instead of recovery catalog
Report of database schema

using target database controlfile instead of recovery catalog
Report of database schema
File K-bytes   Table space      RB segs Datafile Name
-----
1      419840 SYSTEM          ***   /oracle/OraHome1/oradata/GDB1/system01.dbf
2      204800 UNDOTBS1        ***   /oracle/OraHome1/oradata/GDB1/undotbs01.dbf
3      20480  CWMLITE         ***   /oracle/OraHome1/oradata/GDB1/cwmlite01.dbf
4      20480  DRSYS           ***   /oracle/OraHome1/oradata/GDB1/drsys01.dbf
5      141440 EXAMPLE    ***   /oracle/OraHome1/oradata/GDB1/example01.dbf
6      25600  INDX            ***   /oracle/OraHome1/oradata/GDB1/indx01.dbf
7      20480  ODM             ***   /oracle/OraHome1/oradata/GDB1/odm01.dbf
8      10240  TOOLS           ***   /oracle/OraHome1/oradata/GDB1/tools01.dbf
9      25600  USERS           ***   /oracle/OraHome1/oradata/GDB1/users01.dbf
10     39040  XDB             ***   /oracle/OraHome1/oradata/GDB1/xdm01.dbf
11         0 TS1             ***   /oracle/OraHome1/oradata/GDB1/TS1_datafile1.dbf
12         0 TS1             ***   /oracle/OraHome1/oradata/GDB1/TS1_datafile2.dbf
13         0 TS1             ***   /oracle/OraHome1/oradata/GDB1/TS1_datafile3.dbf

List of Temporary Files
=====
File Size(MB) Table space      Maxsize(MB) Tempfile Name
-----
1      20     TEMP              32767      D:\ORACLE\PRODUCT\10.2.0\ORADATA\
GDB1\TEMP01.DBF

RMAN> recover table space TS1;

Starting recover at 30-AUG-07
allocated channel: ORA_DISK_1
channel ORA_DISK_1: sid=11 devtype=DISK

starting media recovery
media recovery complete

Finished recover at 30-AUG-07

RMAN> alter database open;

database opened
```

9.6

9.7 Export and Import a Database (Logical Backup)

While physical backup of database files permit the full reconstruction of database, logical backup is a useful supplement to physical backup for some purposes. For instance, logical backup using the export and import utilities are the only method that Oracle supports for moving an existing database from one platform to another.

Please follow the instructions below to backup a database:

- i. Export the full database to a dump file

```
$ exp system/pwd123 FULL=y FILE='/oracle/data.dmp' LOG='/oracle/export.log'
```

(assuming your system password is *pwd123*, the name of dump file is */oracle/data.dmp* and the name of log file is */oracle/export.log*)

Oracle 9i/10g Example:
<pre>\$ exp system/pwd123 FULL=y FILE='/oracle/data.dmp' LOG='/oracle/export.log'</pre> <p>Connected to: Oracle Database 10g Enterprise Edition Release 10.2.0.1.0 - Production With the Partitioning, OLAP and Data Mining options Export done in WE8MSWIN1252 character set and AL16UTF16 NCHAR character set</p> <p>About to export the entire database exporting table space definitions . exporting profiles . exporting user definitions . exporting roles . exporting resource costs</p> <p style="text-align: center;">//////////////////// // ... exporting ... // ////////////////////</p> <p>. exporting dimensions . exporting post-schema procedural objects and actions . exporting user history table . exporting default and system auditing options . exporting statistics Export terminated successfully without warnings.</p>

- ii. Backup the exported dump file to Vianet Online Backup.

Please refer to the [Section 6.2 Backup files directly to the backup server] for information on how to upload backup files to Vianet Online Backup.

Please follow the instructions below to restore a database:

- iii. Download the backup files from Vianet Online Backup.

Please refer to the [Section 7.1 Restore backup files directly from backup server] for information on how to download backup files from Vianet Online Backup.

- iv. Import the full database from the downloaded backup of dump file

```
$ imp system/pwd123 FULL=y FILE='/oracle/data.dmp' LOG='/oracle/import.log'
```

(assuming your system password is *pwd123*, the name of dump file is */oracle/data.dmp* and the name of log file is */oracle/import.log*)

Oracle 9i/10g Example:
<pre>\$ imp system/pwd123 FULL=y FILE='/oracle/data.dmp' LOG='/oracle/import.log'</pre> <p>Connected to: Oracle Database 10g Enterprise Edition Release 10.2.0.1.0 - Production With the Partitioning, OLAP and Data Mining options</p> <p>Export file created by EXPORT:V10.02.01 via conventional path import done in WE8MSWIN1252 character set and AL16UTF16 NCHAR character set</p> <p>. importing SYSTEM's objects into SYSTEM . importing OLAPSYS's objects into OLAPSYS . importing SYSMAN's objects into SYSMAN . importing SYSTEM's objects into SYSTEM . importing OLAPSYS's objects into OLAPSYS</p> <p style="text-align: center;">//////////////////// // ... importing ... // ////////////////////</p> <p>. importing OLAPSYS's objects into OLAPSYS . importing SYSTEM's objects into SYSTEM . importing OLAPSYS's objects into OLAPSYS</p>

```
. importing SYSMAN's objects into SYSMAN  
. importing SCOTT's objects into SCOTT  
Import terminated successfully without warnings.
```

10 Backup/Restore Microsoft SQL Server 7.0 /

2000 / 2005

This chapter will describe in details how to use Vianet Backup Manager to backup your Microsoft SQL Server 7.0 / 2000 / 2005 server and how you can restore your Microsoft SQL Server 7.0 / 2000 / 2005 server from the backup files.

10.1 Requirements

- i. Vianet Backup Manager must be installed onto the computer running Microsoft SQL Server.
- ii. Data from Microsoft SQL Server will be backed up to a temporary directory before they are sent to Vianet Online Backup. Please make sure you have sufficient space on your computer to store these data when you run the backup job.

10.2 Overview

Vianet Backup Manager will backup your Microsoft SQL Server database(s) by taking the following steps:

- iii. Before running any backup activities, Vianet Backup Manager will run all Pre-Commands of the backup set.
- iv. For each database that is to be backed up, Vianet Backup Manager will issue a database / transaction log backup command to Microsoft SQL Server to backup each database to a Microsoft SQL Server database backup file (*.bak file) and save it in the temporary directory you specified.
- v. After all *.bak files have been spooled to the temporary directories, Vianet Backup Manager will run all Post-Commands of the backup set.
- vi. Upload all files copied to the temporary directory to Vianet Online Backup.
- vii. Remove temporary files from the temporary directory



10.3 How to backup Microsoft SQL Server database(s)

Please follow the instructions below to backup your Microsoft SQL Server databases using Vianet Backup Manager.

- i. Open Vianet Backup Manager

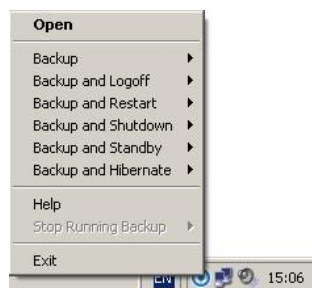
Right click Vianet Backup Manager icon available in the system tray and choose [Open]



- ii. Create a backup set
 - a. To start setting up backup sets, click the  button to open the [Backup Setting] dialog.
 - b. On the left panel, press the  button to create a new backup set.
 - c. On the dialog, choose [MS SQL Server Backup] as the [Type].

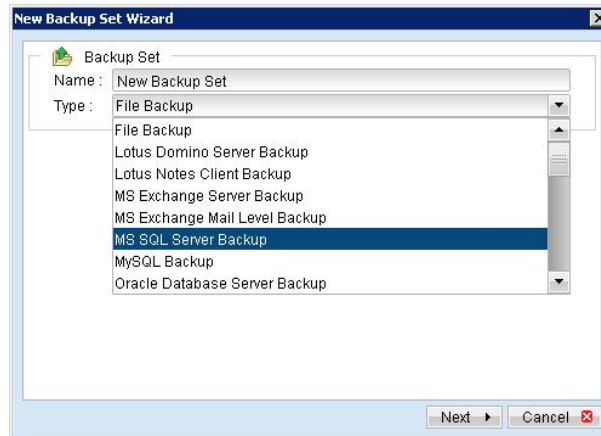

- d. Enter a name for your backup set

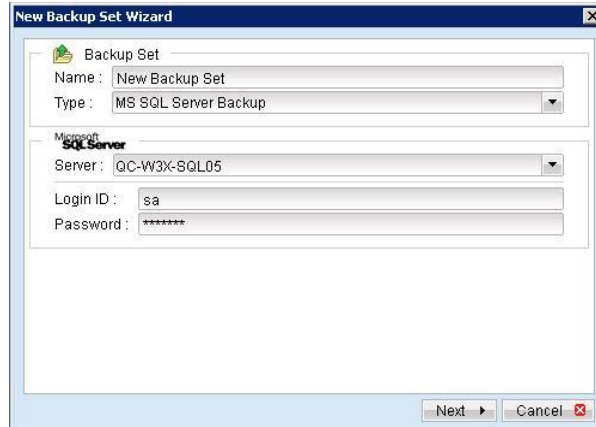

- e. Enter the Microsoft SQL Server administrator username and password
- f. Select the database(s) you want to backup

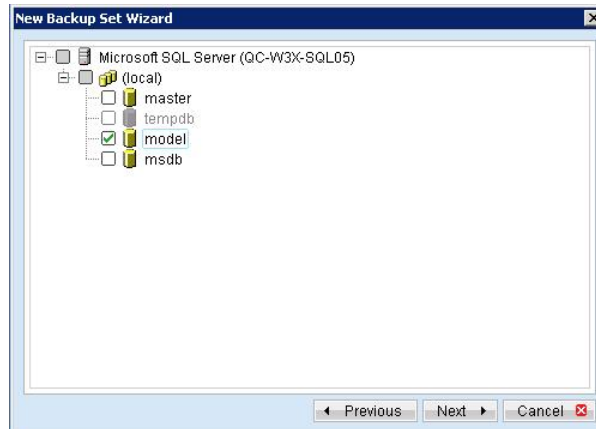

- g. Set the backup schedule for full database backup and transaction log backup

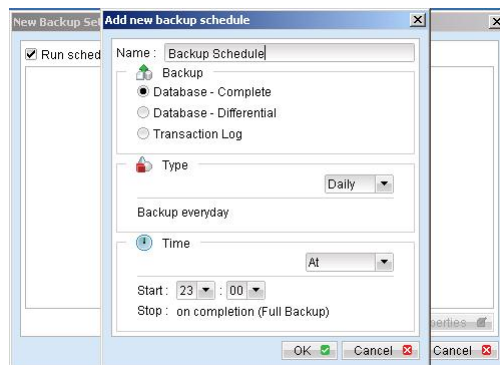

(Note: You can have more than one schedule in a backup set, i.e. you can perform intra-day transaction log backup by adding more than one daily transaction log backup schedule to your backup set)

- h. Set the encryption algorithm, encryption mode and encrypting key for this backup set



(Hint: For maximum security, please select AES (Advanced Encryption Standard) Algorithm, CBC (Cipher Block Chaining) mode and use an encrypting key with more than 8 characters.)

- iii. Run Backup

- a. Press the [Backup] button on the main page of Vianet Backup Manager dialog.
- b. Select the backup type (e.g. Complete, Differential, Transaction Log) you would like to perform. Select the backup set you want to run and select [Offsite Backup Server] to start backing up your files to Vianet Online Backup. If applicable, you can change the In-File Delta Type also.

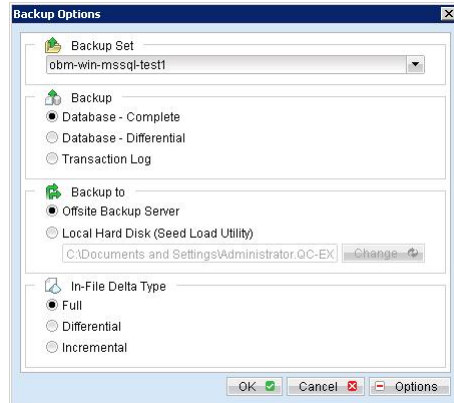

- c. Click [OK] to start backing up your files to Vianet Online Backup.

10.4 How to restore Microsoft SQL Server database(s)

Please follow the instructions below to restore your Microsoft SQL Server databases from Vianet Online Backup.

- i. Download the backup files (.bak) from Vianet Online Backup

Please refer to the [Quick Start - Backup File] section for information on how to download backup files from Vianet Online Backup.

- ii. Open Microsoft SQL Enterprise Manager

You can open Microsoft SQL Enterprise Manager from [Start Menu] -> [Program] -> [Microsoft SQL Server] -> [Enterprise Manager]

- iii. (Optional) Restore "master" database

You need to restore "master" database if you:

- a. are rebuilding all your databases from scratch
- b. have changing any server-wide or database configuration options
- c. have added logins or other login security-related operations.
- d. have created or removed logical backup devices.
- e. have configured the server for distributed queries and remote procedure calls, such as adding linked servers or remote logins.

You do not need to restore your master database if you just want to restore a user database. For more information on Microsoft SQL Server "master" database, please visit <http://www.microsoft.com/sql/>.

To restore "master" database, please do the following:

- a. Start Microsoft SQL Server in "Single User Mode"
 1. Right click your Microsoft SQL Server and select [Properties].

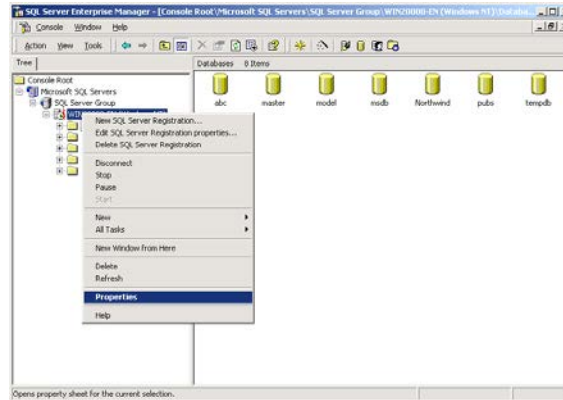

2. Press the [Startup Parameters] button.



3. Add a "-m" parameter to the [Startup Parameters].

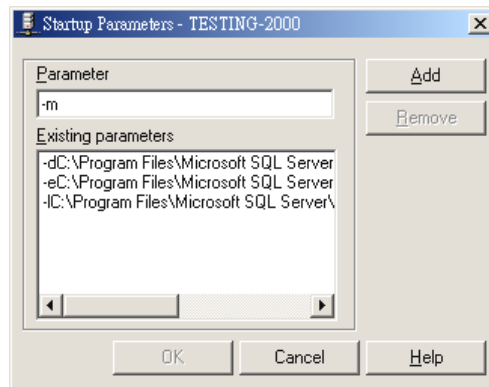

4. Restart Microsoft SQL Server.

From [Enterprise Manager], right click your Microsoft SQL Server and select [Stop] and then [Start].

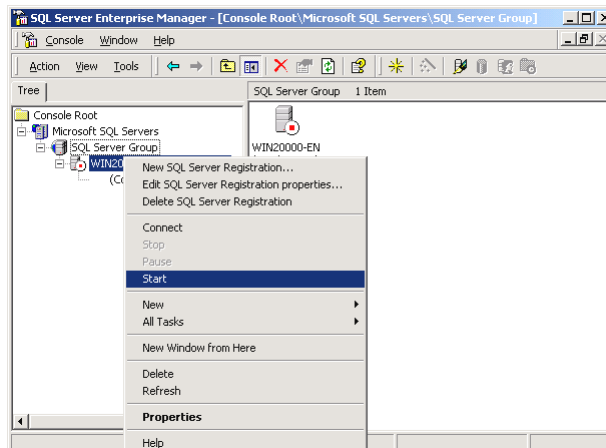
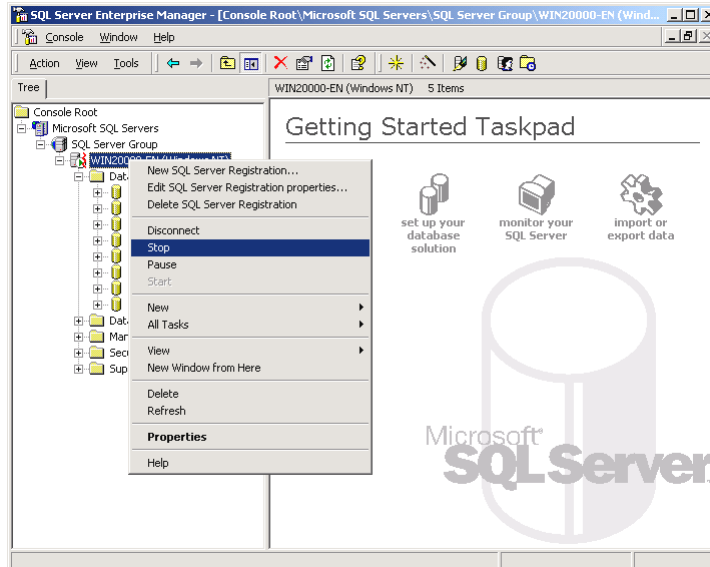

b. Restore "master" database

1. From [Enterprise Manager] -> [Tools] -> [Restore Database].

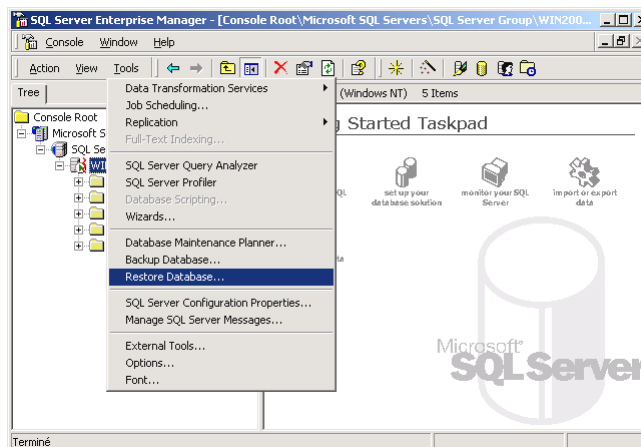

2. Select [master] in the [Restore as database] drop down list.
3. Select the [From device] radio button.
4. Press the [Select Devices] button.

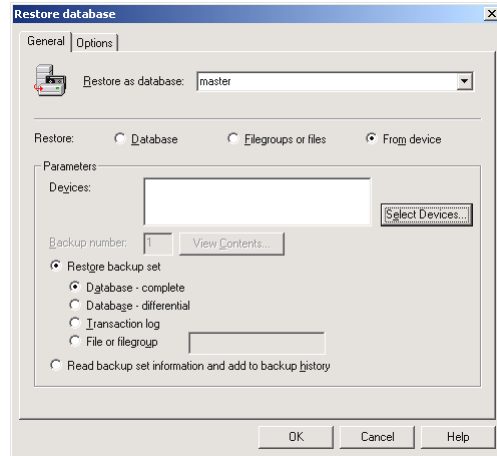

5. From the [Choose Restore Devices], press the [Add] button.

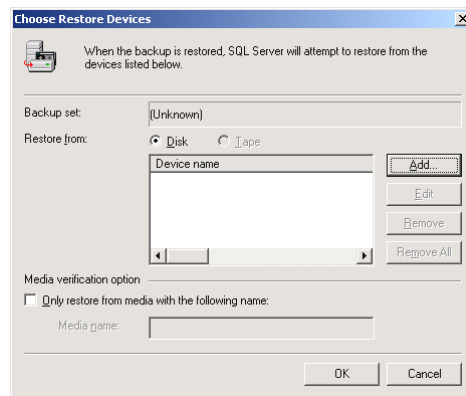

6. From the [Choose Restore Destination] panel, press the [...] button to choose your master backup (*.bak) from your backup files.

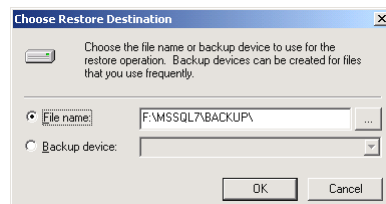

7. Press the [OK] button, to start restoring the "master" database.
- c. Restart Microsoft SQL Server in "Normal Mode"
 1. Remove "-m" parameter from the [Startup Parameters] as in previous step.
 2. Restart your Microsoft SQL Server as in previous step.
 - iv. (Optional) Restore "model", "msdb" and "distribution" database

You need to restore "model" database if you have changed the database template of your SQL Server.

You need to restore "msdb" database if you have changed the scheduling information or you want to restore the backup and restore history of your databases.

You need to restore "distribution" database if you are running the replication components of SQL Server.

You do not need to restore these databases if you just want to restore a user database. For more information on Microsoft SQL Server "model", "msdb" and "distribution" database, please visit <http://www.microsoft.com/sql/>.

You need to restore each of these databases one by one. To restore any of these databases, please do the following:

- a. From [Enterprise Manager] -> [Tools] -> [Restore Database].
 - b. Select the database to be restored in the [Restore as database] drop down list.
 - c. Select the [From device] radio button.
 - d. Press the [Select Devices] button.
 - e. Press the [...] button to choose your backup files (*.bak) for the database to be restored.
 - f. Press the [OK] button.
- v. Restore user database(s)

For each of the database you would like to restore,

- a. From [Enterprise Manager] -> [Tools] -> [Restore Database].
- b. Select the database to be restored in the [Restore as database] drop down list.

- c. Select the [Database] radio button.

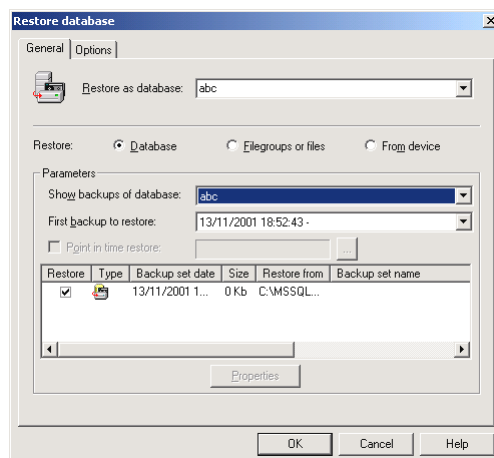

- d. From the [Show backups of database] drop down list, select the database to be restored

- e. From the [First backup to restore] drop down list, select the snapshot of the database you would like to restore to.

You can restore your database to the snapshot of your database at any point of the time between the time you did your full backup and the time you did your last subsequent backup.

- f. Change the [Restore From] entry

If you backup files (*.bak) are not in the default directory, you need to update the full path to your backup files by pressing the [Properties] button.

- g. Press the [OK] button

- vi. All database(s) restored successfully

11

Backup/Restore Lotus Domino / Notes

This chapter will describe in details how to use Vianet Backup Manager to backup your Lotus Domino server / Notes client 5 / 6 / 6.5 and how you can restore your Lotus Domino server / Notes client 5 / 6 / 6.5 from the backup files.

11.1 Requirements

- i. Vianet Backup Manager must be installed onto the computer running Lotus Domino server / Notes client.
- ii. Data from Lotus Domino server / Notes client will be backed up to a temporary directory before they are sent to Vianet Online Backup. Please make sure you have sufficient disk space on your computer to store these data when you run the backup job.
- iii. Lotus Domino server must runs with archive transaction logging enabled

To set up transaction logging in archive style, please do the following:

- a. Ensure that all databases to be logged reside in the Domino data directory, either at the root or in subdirectories.
- b. From the Domino Administrator, click the Configuration tab.
- c. In the "Use Directory on" field, choose the server's Domino Directory.
- d. Click Server Configuration, and then click Current Server Document.
- e. Click the Transactional Logging tab.
- f. Complete these fields, and then save the document.

Field	Enter
Transactional Logging	Choose Enabled. The default is Disabled.
Log path	Path name location of the transaction log. The default path name is \LOGDIR in the Domino data directory, although it is strongly recommended to store the log on a separate, mirrored device, such as a RAID (Redundant Array of Independent Disks) level 0 or 1 device with a dedicated controller. The separate device should have at least 1GB of disk space for the transaction log. If you are using the device solely for storing the transaction log, set the "Use all available space on log device" field to Yes.
Logging style	Choose Archive. The default is Circular.
Maximum log space	The maximum size, in MB, for the transaction log. Default is 192MB. Maximum is 4096MB (4GB). Domino formats at least 3 and up to 64 log files, depending on the maximum log space you allocate.
Use all available space on log device	Choose one: <ul style="list-style-type: none"> • "Yes" to use all available space on the device for the transaction log. This is recommended if you use a separate device dedicated to storing the log. If you choose "Yes", you don't need to enter a value in the "Maximum log space" field. • "No" to use the default or specified value in the "Maximum log space" field.
Automatic fixup of corrupt databases	Choose one: <ul style="list-style-type: none"> • Enabled (default). If a database is corrupt and Domino cannot use the transaction log to recover it, Domino runs the Fixup task, assigns a new DBIID, and notifies the administrator that a new database backup is required.

	<ul style="list-style-type: none"> Disabled. Domino does not run the Fixup task automatically and notifies the administrator to run the Fixup task with the -J parameter on corrupt logged databases.
Runtime / Restart performance	<p>This field controls how often Domino records a recovery checkpoint in the transaction log, which affects server performance.</p> <p>To record a recovery checkpoint, Domino evaluates each active logged database to determine how many transactions would be necessary to recover each database after a system failure. When Domino completes this evaluation, it:</p> <ul style="list-style-type: none"> Creates a recovery checkpoint record in the transaction log, listing each open database and the starting point transaction needed for recovery Forces database changes to be saved to disk if they have not been saved already <p>Choose one:</p> <ul style="list-style-type: none"> Standard (default and recommended). Checkpoints occur regularly. Favor runtime. Domino records fewer checkpoints, which requires fewer system resources and improves server run time performance. Favor restart recovery time. Domino records more checkpoints, which improves restart recovery time because fewer transactions are required for recovery.

Notes:

You can only run transaction log backup if you have transaction logging enabled and you are using archive mode. This command does not apply if you have transaction logging enabled not in archive mode or if transaction logging is not enabled at all. If you try to issue it, you will receive an error message.

11.2 Overview

Vianet Backup Manager will backup your Lotus Domino server / Notes client by taking the following steps:

- i. Run all Pre-Commands of this backup set
- ii. If the backup type to run is [Database Backup type],
 - a. all file(s) / database(s) selected are copied to the temporary directory specified by this backup set
 - b. the notes.ini file, if selected, will be copied to the temporary directory
 - c. only filled log extents will be copied to the temporary directory, and the Domino server is notified of their availability for reuse (for Domino server only)
- iii. (for Domino server only) If the backup type to run is [Transaction Log Backup type],
 - a. only filled log extents will be copied to the temporary directory, and the Domino server is notified of their availability for reuse
- iv. Run all Post-Commands of this backup set
- v. Upload all files copied to the temporary directory to Vianet Online Backup
- vi. Remove temporary files from the temporary directory

11.3 How to backup Lotus Domino / Notes database(s) / file(s) on Windows



Please follow the instructions below to backup your Lotus Domino server / Notes client databases / files using Vianet Backup Manager.

- i. Open Vianet Backup Manager

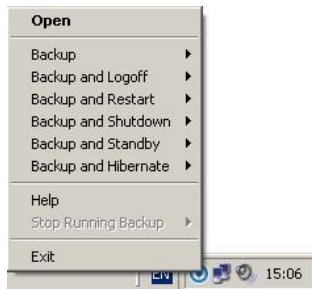
Right click Vianet Backup Manager icon available in the system tray and choose [Open]



- ii. Create a backup set

- b. To start setting up backup sets, click the  button to open the [Backup Setting] dialog.
- c. On the left panel, press the  button to create a new backup set.
- d. On the dialog, choose [Lotus Domino Server Backup] (or [Lotus Notes Client Backup] for Lotus Notes) as the [Type].

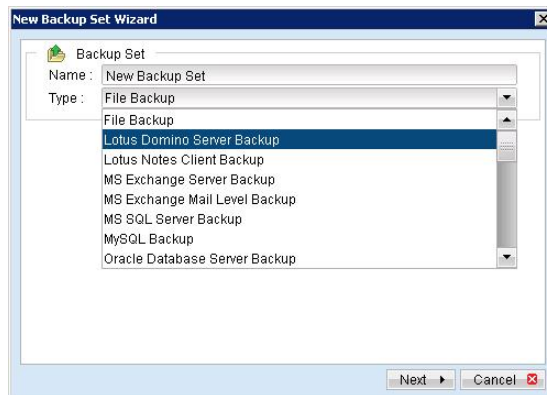

- e. Enter a name for your backup set.

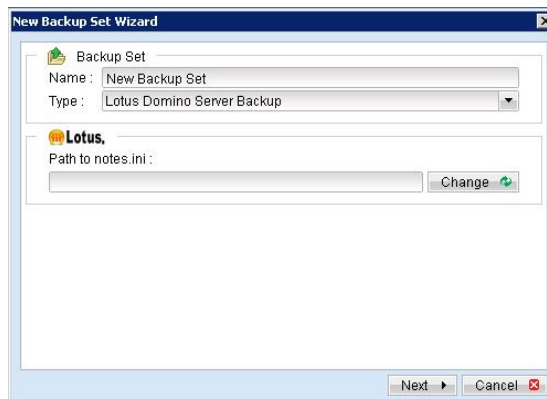

- f. Select the location of the "note.ini" file.
- g. Select the database(s) / file(s) you want to backup

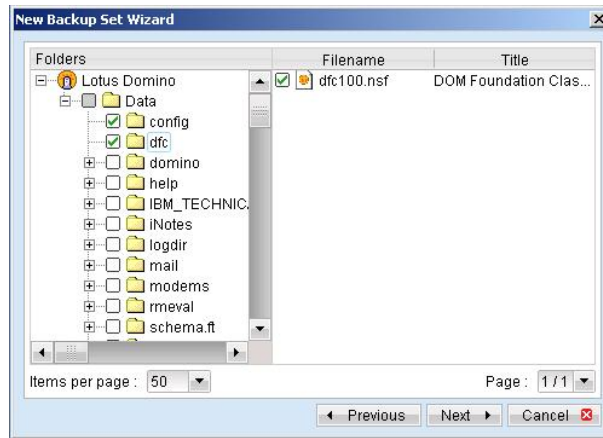

- h. Set the backup schedule for Database Backup

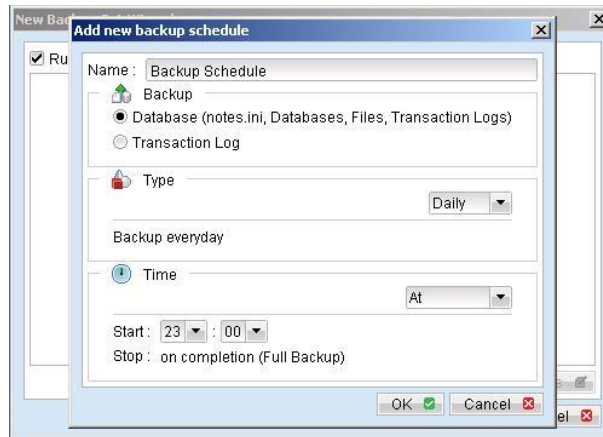

- i. Set the backup schedule for Transaction Log Backup (for Domino server only)
(Note: You can have more than one schedule in a backup set, i.e. you can perform intra-day transaction log backup by adding more than one daily transaction log backup schedule to your backup set)
- j. Set the encryption algorithm, encryption mode and encrypting key for this backup set



(Hint: For maximum security, please select AES (Advanced Encryption Standard) Algorithm, CBC (Cipher Block Chaining) mode and use an encrypting key with more than 8 characters.)

- iii. Run Backup
 - a. Press the [Backup] button on the main page of Vianet Backup Manager dialog.
 - b. Select the backup type (e.g. Database, Transaction Log) you would like to perform (for Domino server only). Select the backup set you want to run and select [Offsite Backup Server] to start backing up your files to Vianet Online Backup. If applicable, you can change the In-File Delta Type also.

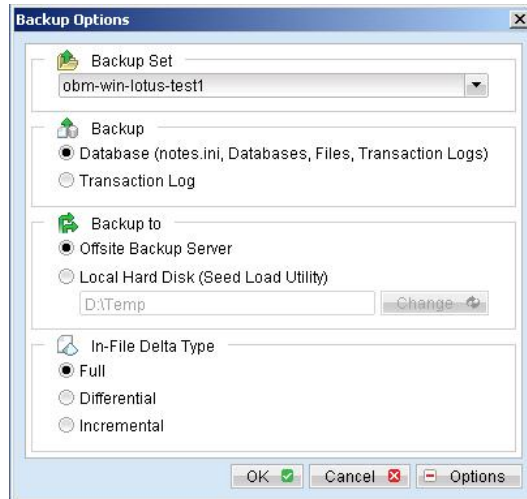

- c. Click [OK] to start backing up your files to Vianet Online Backup.

11.4 How to restore Lotus Domino / Notes database(s) / file(s) on Windows

Please follow the instructions below to restore Lotus Domino server / Notes client database(s) / file(s) from Vianet Online Backup.

- i. Install Lotus Domino server / Notes client back to its original folder (if required)
- ii. Install Vianet Backup Manager

Please refer to the [Installation] section for information on how to install Vianet Backup Manager onto your computer.
- iii. Shutdown Lotus Domino Server
- iv. If you want to perform a full domino restore (restore all databases and files):
 - a. Download the backup files to be restored from Vianet Online Backup and save them back to its original location. It includes "notes.ini", all backup files from the lotus domino data directory and all archived transaction logs
 - b. Modify the "DominoRecover.bat" located under the bin directory of the Vianet Backup Manager installation to reflect your setup. You need to specify the lotus executable directory.

For example change the PROGRAM_DIR to:
PROGRAM_DIR=C:\Lotus\Domino

- c. Run "DominoRecover.bat" and press 'Y' to continue.
For example: **C:\program files\obm\bin\DominoRecover.bat**

This will run media recovery for all databases (*.nsf and mail.box) found under the Lotus data directory (e.g. C:\Lotus\Domino\Data). You should see something similar to the screen below.

```

Media Recovery Example:

C:\program files\obm\bin>DominoRecover.bat
Media Recovery Utility for Lotus Domino 5.0 or above

Please make sure that you have done the following:
1. Reinstall Lotus Domino on this computer in the same directory
2. Restore Notes.ini to the Lotus Domino installation directory
   (e.g. C:\Lotus\Domino)
3. Restore Domino Data directory back to the directory defined
   in Notes.ini (e.g. C:\Lotus\Domino\Data)
4. Restore all archived transaction logs to the directory defined
   in Notes.ini (e.g. C:\Lotus\Domino\Data\logdir)

Continue ? (Y) or (N) y
Running media recovery ...
Please wait, creating new transaction logs in directory: C:\logdir\
02/12/2003 14:39:19 Recovery Manager: Restart Recovery complete. (0/0
databases needed full/partial recovery)
Media Recovery Replay (122 MB): 10% 20% 30% 40% 50% 60% 70% 80% 90% 100%
02/12/2003 14:39:22 Recovery Manager: Media Recovery complete for
C:\Lotus\Domino\Data\admin4.nsf, last update applied .

Backup file C:\Lotus\Domino\Data\admin4.nsf recovered.

.....

Media Recovery Replay (122 MB): 10% 20% 30% 40% 50% 60% 70% 80% 90% 100%
02/12/2003 14:40:57 Recovery Manager: Media Recovery complete for
C:\Lotus\Domino\Data\statrep.nsf, last update applied .

Backup file C:\Lotus\Domino\Data\statrep.nsf recovered.

C:\program files\obm\bin>

```

- d. All content of all database(s) are now rolled forward to the last committed transaction found in the last archived transaction log.
 - e. Restart Lotus Domino server
- v. If you just want to restore a single database:
- a. Download the database file to be restored from Vianet Online Backup and save them back to its original location.
 - b. (optional) If you need to perform media recovery on this database, please download all archived transaction logs and save them back to its original location
 - c. Modify the "DominoRecover.bat" located under the bin directory of the Vianet Backup Manager installation to reflect your setup.

For example we will recover the "admin4.nsf" and have restored the file to C:\restore\notesdata, change the tags to:

```

PROGRAM_DIR=C:\Lotus\Domino
INPUTFILE=C:\restore\notesdata\admin4.nsf
RESTOREDB=C:\Lotus\Domino\Data\admin4.nsf
RECDATE=18/01/2007
RECTIME=00:02

```

- d. Run "DominoRecover.bat".

You should see something similar to the screen below.

```

Media Recovery Example:

C:\program files\obm>DominoRecover.bat
Media Recovery Utility for Lotus Domino 5.0 or above

Running media recovery ...
Restart Analysis (0 MB): 100%
18/01/2007 14:42:15 Recovery Manager: Restart Recovery complete. (0/0
databases needed full/partial recovery)
Media Recovery Replay (122 MB): 10% 20% 30% 40% 50% 60% 70% 80% 90% 100%
18/01/2007 14:42:17 Recovery Manager: Media Recovery complete for
C:\Lotus\Domino\data\admin4.nsf, last update applied .

Backup file C:\Lotus\Domino\data\admin4.nsf recovered.

C:\Lotus\Domino>

```

- e. All content of the database are now rolled forward to the last committed transaction found in the last archived transaction log.
- f. Restart Lotus Domino Server

11.5 How to backup Lotus Domino / Notes database(s) / file(s) on Linux

Please make sure that the user running Vianet Backup Manager have sufficient privileges to read and write to the "notesenv" file located in the "bin" subdirectory of where Vianet Backup Manager is installed. This file is used by Vianet Backup Manager to store the location of the domino/notes application executables. e.g. use chmod to set read, write & execute permissions



```
# cd $OBM_HOME/bin  
# chmod 777 notesenv
```

Please follow the instructions below to backup your Lotus Domino server / Notes client databases / files using Vianet Backup Manager.

- i. Open Vianet Backup Manager by typing the following in a terminal

```
# cd $OBM_HOME  
# ./bin/BackupManager.sh
```

- ii. Create a backup set

- a. To start setting up backup sets, click the  button to open the [Backup Setting] dialog.
- b. On the left panel, press the  button to create a new backup set.
- c. On the dialog, choose [Lotus Domino Server Backup] (or [Lotus Notes Client Backup] for Lotus Notes) as the [Type].

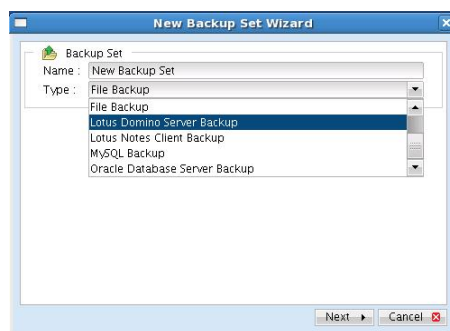

- d. Enter a name for your backup set

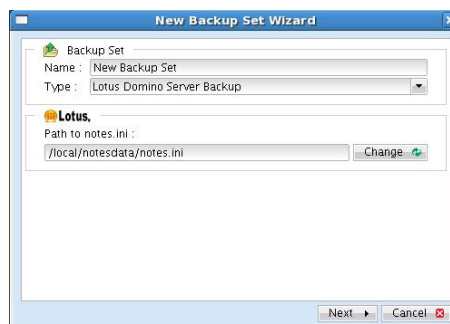

- e. Select the location of the "note.ini" file. The default path for this will be in the /local/notesdata folder.
- f. Select the database(s) / file(s) you want to backup

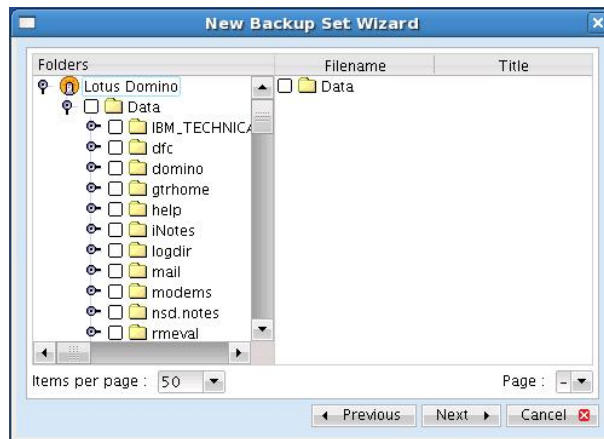

- g. Enter a temporary location to store the backup files before they are sent to Vianet Online Backup. Please make sure that the user running Vianet Backup Manager have sufficient privileges to read and write to this location and sufficient space is available.
- h. Set the backup schedule for Database Backup

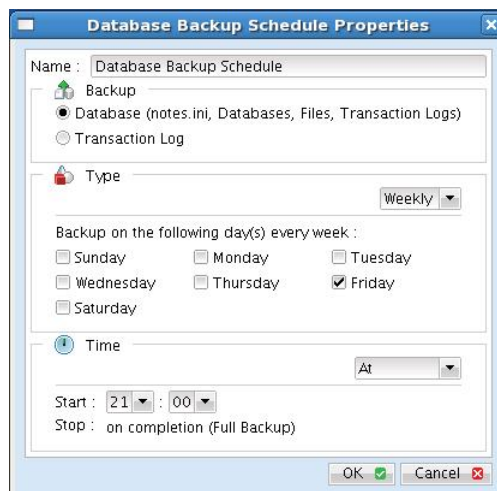
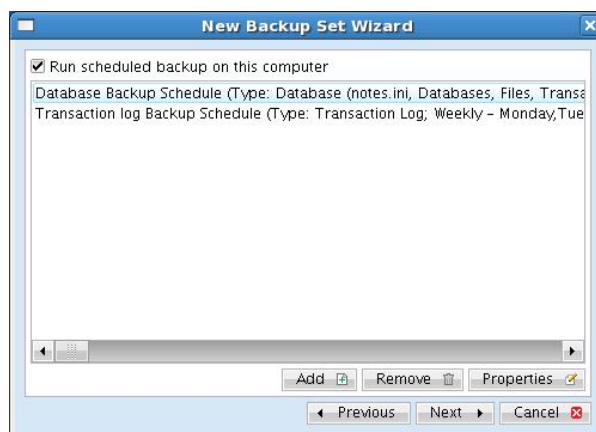

- i. Set the backup schedule for Transaction Log Backup (for Domino server only)
(Note: You can have more than one schedule in a backup set, i.e. you can perform intra-day transaction log backup by adding more than one daily transaction log backup schedule to your backup set)
- j. Set the encryption algorithm, encryption mode and encrypting key for this backup set

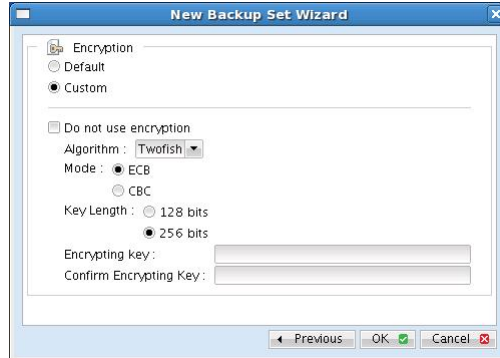

(Hint: For maximum security, please select AES (Advanced Encryption Standard) Algorithm, CBC (Cipher Block Chaining) mode and use an encrypting key with more than 8 characters.)

- iii. Run Backup
 - a. Press the [Backup] button on the main page of Vianet Backup Manager dialog.
 - b. Select the backup type (e.g. Database, Transaction Log) you would like to perform (for Domino server only). Select the backup set you want to run and select [Offsite Backup Server] to start backing up your files to Vianet Online Backup. If applicable, you can change the In-File Delta Type also.

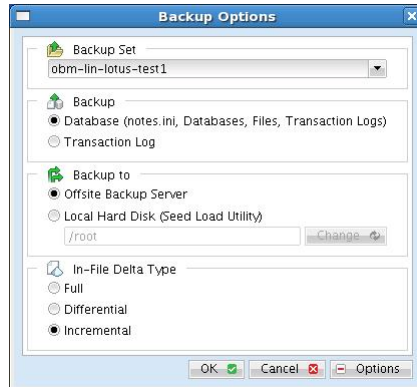

- c. Click [OK] to start backing up your files to Vianet Online Backup.
- d. You should get something similar to the screen shot below.

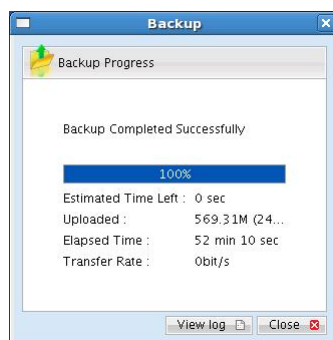

11.6 How to restore Lotus Domino / Notes database(s) / file(s) on Linux

Please follow the instructions below to restore Lotus Domino server / Notes client database(s) / file(s) from Vianet Online Backup.

- i. Install Lotus Domino server / Notes client back to its original folder (if required)
- ii. Install Vianet Backup Manager

Please refer to the [Installation] section for information on how to install Vianet Backup Manager onto your computer.
- iii. Shutdown Lotus Domino Server
- iv. If you want to perform a full domino restore (restore all databases and files):
 - a. Download the backup files to be restored from Vianet Online Backup and save them back to its original location. It includes notes.ini, all backup files from the lotus domino data directory and all archived transaction logs. If you encounter any access problems, please try restoring using the "root" user.
 - b. Make sure that the owner and group permissions of the restored files are the notes user

For example: `# chown -R notes:notes /local/notesdata`

This will assign the owner and group to all files and directories within /local/notesdata.
 - c. Modify the "DominoRecover.sh" located under the bin directory of the Vianet Backup Manager installation to reflect your setup. You need to specify the data directory and the lotus executable directory.

For example change the DATA_DIR and LOTUS tags to:

```
DATA_DIR=/local/notesdata
LOTUS=/opt/ibm/lotus
```
 - d. Make sure the current user is the notes user before running the "DominoRecover.sh".
 - e. Run "DominoRecover.sh" and press 'Y' to continue.

For example: `#!/usr/local/obm/bin/DominoRecover.sh`

This will run media recovery for all databases (*.nsf and mail.box) found under the Lotus data directory (e.g. /local/notesdata). You should see something similar to the screen below.

```

Media Recovery Example:
bash-3.00$ cd /usr/local/obm/bin
bash-3.00$ ./DominoRecover.sh
Media Recovery Utility for Lotus Domino 5.0 or above

Please make sure that you have done the following:
1. Reinstall Lotus Domino on this computer in the same directory
2. Restore Notes.ini to the Lotus Domino installation directory
   (e.g. /local/notesdata)
3. Restore Domino Data directory back to the directory defined
   in Notes.ini (e.g. /local/notesdata)
4. Restore all archived transaction logs to the directory defined
   in Notes.ini (e.g. /local/notesdata/logdir)

Continue ? (Y) or (N) y

Running media recovery ...
directory /local/notesdata// already exists
Please wait, creating new transaction logs in directory: /local/notesdata/logdir/
02/01/2007 11:38:43 AM Recovery Manager: Restart Recovery complete. (0/0 databases
needed full/partial recovery)
02/01/2007 11:38:45 AM Recovery Manager: Assigning new DBIID for
/local/notesdata/notes.nsf (need new backup for media recovery).
Media Recovery Replay (0 MB): 100%
02/01/2007 11:38:45 AM Recovery Manager: Media Recovery complete for
/local/notesdata/dfc/dfc100.nsf, last update applied .

Backup file /local/notesdata/dfc/dfc100.nsf recovered.
Media Recovery Replay (0 MB): 100%
02/01/2007 11:38:46 AM Recovery Manager: Media Recovery complete for

```

```

/local/notesdata/help/decsdoc.nsf, last update applied .
...
Backup file /local/notesdata/iNotes/help70_iwa_en.nsf recovered.
Media Recovery Replay (0 MB): 100%
02/01/2007 11:38:50 AM Recovery Manager: Media Recovery complete for
/local/notesdata/mail/notes.nsf, last update applied .
Backup file /local/notesdata/mail/notes.nsf recovered.
bash-3.00$

```

- f. All content of all database(s) are now rolled forward to the last committed transaction found in the last archived transaction log.
- g. Restart Lotus Domino server
- v. If you just want to restore a single database:
 - a. Download the database file to be restored from Vianet Online Backup and save them back to its original location.
 - b. (optional) If you need to perform media recovery on this database, please download all archived transaction logs and save them back to its original location
 - c. Modify the "DominoRecover.sh" located under the bin directory of the Vianet Backup Manager installation to reflect your setup.

For example we will recover the "admin4.nsf" and have restored the file to /restore/local/notesdata, change the tags to:

```

DATA_DIR=/local/notesdata
LOTUS=/opt/ibm/lotus
INPUTFILE=/restore/local/notesdata/admin4.nsf
RESTOREDB=/local/notesdata/admin4.nsf
RECDATE=18/01/2007
RECTIME=22:41

```

- d. Make sure the current user is the notes user before running the "DominoRecover.sh".
- e. Run "DominoRecover.sh".

You should see something similar to the screen below.

```

Media Recovery Example:
bash-3.00$ cd /usr/local/obm/bin
bash-3.00$ ./DominoRecover.sh
Media Recovery Utility for Lotus Domino 5.0 or above

directory /local/notesdata// already exists

Recovering backup file ...

Restart Analysis (0 MB): 100%
18/01/2007 03:35:56 PM Recovery Manager: Restart Recovery complete. (0/0 databa ses
needed full/partial recovery)
Media Recovery Replay (1 MB): 30% 50% 80% 100%
18/01/2007 03:35:57 PM Recovery Manager: Media Recovery complete for /local/res
tore/local/notesdata/admin4.nsf, last update applied .

Backup file /local/restore/local/notesdata/admin4.nsf recovered.

Taking database /local/notesdata/admin4.nsf offline ...

Restoring database /local/notesdata/admin4.nsf
from recovered backup file /local/restore/local/notesdata/admin4.nsf ...
Database file /local/notesdata/admin4.nsf restored from /local/restore/local/not
esdata/admin4.nsf

Bringing database /local/notesdata/admin4.nsf online ...

Program completed successfully.
bash-3.00$

```

- f. All content of the database are now rolled forward to the last committed transaction found in the last archived transaction log.
- g. Restart Lotus Domino Server

12 Backup/Restore Microsoft Exchange Server

This chapter will describe in details how to use Vianet Backup Manager to backup your Microsoft Exchange Server 2000 / 2003 / 2007 and how you can restore your Microsoft Exchange Server 2000 / 2003 / 2007 from the backup files.

12.1 Requirements

- i. Microsoft Exchange Server 2000 with Services Pack 3 and post-SP3 update rollup installed. Please refer to <http://www.microsoft.com/exchange/> for more information.
Or
Microsoft Exchange Server 2003 or Microsoft Exchange Server 2007.
- ii. Vianet Backup Manager must be installed onto the computer running Microsoft Exchange Server 2000 / 2003 / 2007.
- iii. Data from Microsoft Exchange Server will be backed up to a temporary directory before they are sent to Vianet Online Backup. Please make sure you have sufficient space on your computer to store these data when you run the backup job.

12.2 Overview

A Microsoft Exchange Server 2000/2003/2007 stores its data in Windows Active Directory as well as in its databases. To fully backup a Microsoft Exchange Server 2000/2003/2007, you need to backup the following components:

- i. **Windows System State**

The Windows System State contains the information about your Windows system, including Windows Active Directory. A Microsoft Exchange Server 2000 / 2003 / 2007 stores some of its configuration, e.g. email accounts and mailbox properties, inside Windows Active Directory. It is important that Windows Active Directory is backed up properly when backing up a Microsoft Exchange Server.

Active Directory is stored inside a Windows Server running as Windows domain controller. If your Exchange Server is a domain controller, you can simply backup the Windows System State of your Exchange Server. If your Exchange Server is running as a member server, you will need to install another copy of Vianet Backup Manager onto the domain controller to backup the Windows System State of inside the domain controller.

For more information on Active Directory, please refer to <http://www.microsoft.com/windows2000/technologies/directory/ad/default.asp>
- ii. **Microsoft Information Store**
Exchange Server stores all emails and documents inside its databases, which are grouped together as storage groups inside Microsoft Information Store. It is important that Microsoft Information Store is fully backed up when backing your Exchange Server.
- iii. **Microsoft Site Replication Service**
Microsoft Site Replication Service is installed automatically when exchange server site replication feature is enabled. Microsoft Site Replication stores its runtime and configuration information inside its own database. If you are running your Exchange Server with Site Replication Service enabled, please make sure that you backup the site replication database as well.
- iv. **Microsoft Key Management Service (Exchange 2000 only)**
Similarly, if you have setup your Exchange Server with Key Management Services enabled, please make sure that you backup the key management database as well.

Vianet Backup Manager will backup your Microsoft Exchange Server by taking the following steps:

- v. Run all Pre-Commands of this backup set
- vi. If the backup type to run is [Database Backup type],

- a. Windows System State will be backed up to a temporary directory specified in its backup set
- b. All exchange database(s) selected are backed up to a temporary directory specified in its backup set
- vii. If the backup type to run is [Transaction Log Backup type],
 - a. New transaction log extents generated since last backup will be copied to the temporary directory
- viii. Remove transaction log extents backed up from the Exchange Server
- ix. Run all Post-Commands of this backup set
- x. Upload all backup files from the temporary directory to Vianet Online Backup
- xi. Remove temporary files from the temporary directory

12.3 How to backup Microsoft Exchange Server



Please follow the instructions below to backup your Microsoft Exchange Server 2000 / 2003 / 2007 using Vianet Backup Manager:

- i. Open Vianet Backup Manager

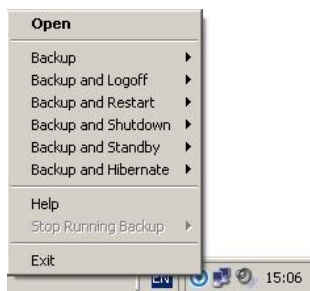
Right click Vianet Backup Manager icon available in the system tray and choose [Open]



- ii. Create a backup set

- a. To start setting up backup sets, click the  button to open the [Backup Setting] dialog.
- b. On the left panel, press the  button to create a new backup set.
- c. On the dialog, choose [MS Exchange Server Backup] as the [Type].

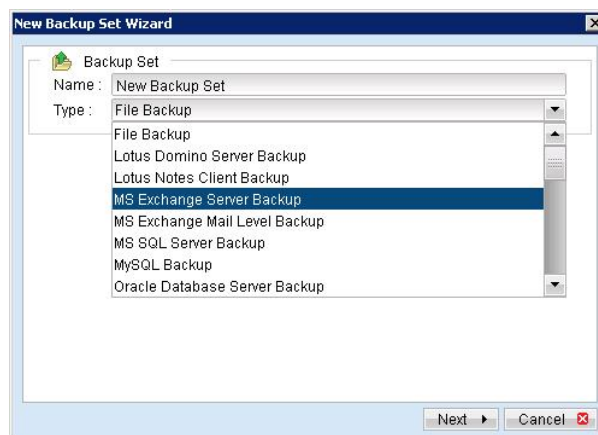

- d. Enter a name for your backup set.
- e. Select the database(s) to be backed up.

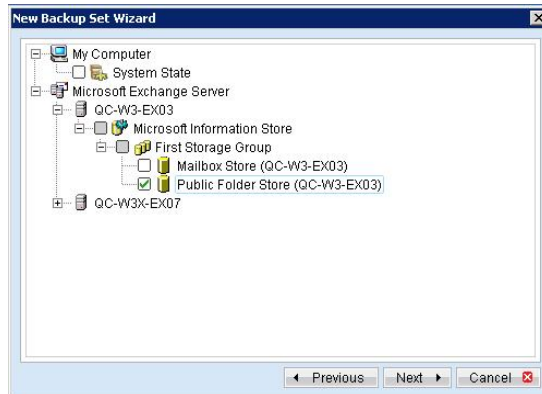

If this Exchange Server is also a domain controller of this Active Directory, select the [System State] checkbox as well. Otherwise, please install Vianet Backup Manager to the domain controller of this Active Directory and select the [System State] checkbox on that computer

- f. Enter a temporary directory for storing the backup files before they are sent to Vianet Online Backup.
- g. Set the backup schedule for Database Backup.

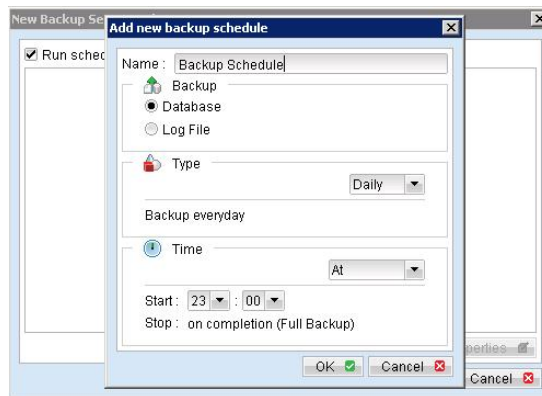

- h. Set the backup schedule for Transaction Log Backup.
(Note: You can have more than one schedule in a backup set, i.e. you can perform intra-day transaction log backup by adding more than one daily transaction log backup schedule to your backup set)
- i. Set the encryption algorithm, encryption mode and encrypting key for this backup set.



(Hint: For maximum security, please select AES (Advanced Encryption Standard) Algorithm, CBC (Cipher Block Chaining) mode and use an encrypting key with more than 8 characters.)

- iii. Run Backup
 - a. Press the [Backup] button on the main page of Vianet Backup Manager dialog.
 - b. Select the backup type (e.g. Database, Log Files) you would like to perform. Select the backup set you want to run and select [Offsite Backup Server] to start backing up your files to Vianet Online Backup. If applicable, you can change the In-File Delta Type also.

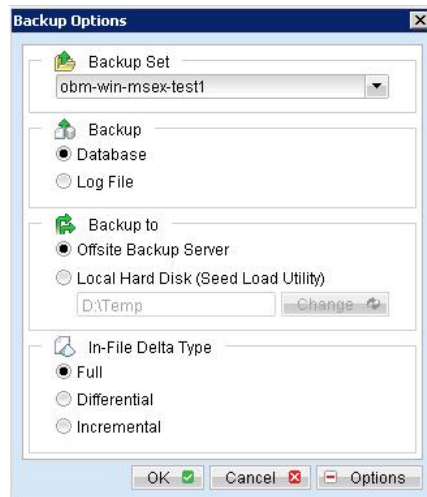

- c. Click [OK] to start backing up your files to Vianet Online Backup.
- d. You should get something similar to the screen shot below.

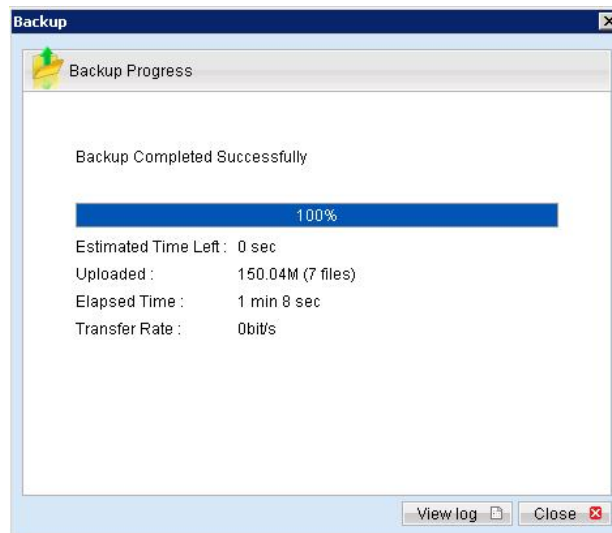

12.4 How to restore Microsoft Exchange Server

Please follow the instructions below to restore Microsoft Exchange Server 2000 / 2003 / 2007 from Vianet Online Backup.

- i. Prepare the system for your Exchange Server (if required)

Install the original version of Windows and Exchange Server (with the same level of service pack installed as in the original system) back to your computer

ii. Restore Windows Active Directory (if required)

If you have re-installed Windows, please download the Windows System State backup file, named [SystemState.bkf], from Vianet Online Backup and then use [NTBackup.exe] to restore your Windows System State to its backup time from the backup file by following the instructions below:

- a. Run [NTBackup.exe] from [Start] -> [Run]
- b. Press the [Restore Wizard] button and then press the [Next] button
- c. Press the [Import] button and use the [Browse] button to select the backup file [SystemState.bkf] downloaded
- d. Select the checkbox next to the description that matches your backup file
- e. Press the [Next] button and then the [Finish] button

iii. Install Vianet Backup Manager (if required)

Please refer to the [Installation] section for information on how to install Vianet Backup Manager onto your computer.

iv. Startup the [Microsoft Information Store] services from Windows Services

v. Restore exchange database(s) from backup:

- a. Download the database backup files to be restored from the Vianet Online Backup (or find the cached copy available in the temporary directory defined in your backup set) and save them to your hard disk (please make sure the directory structure is the same as it appears on the browser), namely:

```
->[C:]
-->[backup]
---->[ABC]
----->[Microsoft Information Store]
----->[First Storage Group]
----->[Mailbox Store(ABC)]
----->Priv1.edb
----->Priv1.stm
----->[Public Folder Store(ABC)]
----->Pub1.edb
----->Pub1.stm
----->E0000001.log
```

- b. If the database to be restored exists on your computer already, please dismount it from the services using [Start] -> [Program] -> [Microsoft Exchange] -> [System Manager]
- c. Use [ExchangeRestore.exe] (use [ExRestore2k7.exe] for MS Exchange 2007) from the [bin] directory under the installation directory of Vianet Backup Manager (e.g. C:\Program Files\Vianet Backup Manager\bin\ExchangeRestore.exe) to restore the exchange database(s).

Simply run [ExchangeRestore.exe] to print the usage

ExchangeRestore.exe Usage:	
C:\Program Files\Vianet Backup Manager\bin> ExchangeRestore.exe	
Microsoft Exchange Server 2000/2003 Backup Recovery Utility	
Usage:	
ExchangeRestore DIR=path SERVER=server TEMP=tempDir [SERVICE=service [STORAGE=storage [DATABASE=database]]]	
DIR	Directory containing all backup files
SERVER	Name of Exchange Server to be restored
TEMP	Temporary directory to be used during restore
	Please specific a path with plenty of free space
SERVICE	Name of Exchange Service to be restored. It must be either

```

"Microsoft Information Store", "Microsoft Key Management Service"
or "Microsoft Site Replication Service"
STORAGE Name of storage group to be restored
DATABASE Name of database to be restored

Examples:
1. To restore an exchange server:
ExchangeRestore DIR="C:\Backup" SERVER="ExchangeServer" TEMP="C:\Temp"

2. To restore the information store:
ExchangeRestore DIR="C:\Backup" SERVER="ExchangeServer" TEMP="C:\Temp"
SERVICE="Microsoft Information Store"

3. To restore an exchange storage group:
ExchangeRestore DIR="C:\Backup" SERVER="ExchangeServer" TEMP="C:\Temp"
SERVICE="Microsoft Information Store" STORAGE="StorageGroup1"

4. To restore an exchange database:
ExchangeRestore DIR="C:\Backup" SERVER="ExchangeServer" TEMP="C:\Temp"
SERVICE="Microsoft Information Store" STORAGE="StorageGroup1"
DATABASE="Database1"

where
"C:\Backup" is the directory containing all backup files
"ExchangeServer" is the server name of an exchange server
"C:\Temp" is the temporary directory to be used
"StorageGroup1" is the name of a storage group
"Database1" is the name of a database

```

- d. (Example 1) To restore all databases from backup available in [F:\Backup] to an exchange server named [WIN2000SVR] using the temporary directory [F:\Temp], you can use this command:

E:\Program Files\Vianet Backup Manager\bin> ExchangeRestore DIR="F:\Backup"
TEMP="F:\Temp" SERVER="WIN2000SVR"

```

Exchange Server Recovery Example:

E:\Program Files\Vianet Backup Manager\bin> ExchangeRestore DIR="F:\Backup"
TEMP="F:\Temp" SERVER="WIN2000SVR"

Microsoft Exchange Server 2000/2003 Backup Recovery Utility

[Start] Exchange Server - 'WIN2000SVR'
[Start] Service - 'Microsoft Information Store'
[Start] Storage Group - 'First Storage Group'
[Start] Database - 'Mailbox Store (WIN2000SVR)'
Restoring file 'E:\Program Files\Exchsrvr\mdbdata\priv1.edb' ...
Restoring file 'E:\Program Files\Exchsrvr\mdbdata\priv1.stm' ...
[End] Database - 'Mailbox Store (WIN2000SVR)'
[Start] Database - 'Public Folder Store (WIN2000SVR)'
Restoring file 'E:\Program Files\Exchsrvr\mdbdata\publ.edb' ...
Restoring file 'E:\Program Files\Exchsrvr\mdbdata\publ.stm' ...
[End] Database - 'Public Folder Store (WIN2000SVR)'
[Start] Restoring transaction log - 'First Storage Group'
Restoring Log File 'F:\Temp\restore.tmp\First Storage Group\E00000B3.log' ...
Restoring Log File 'F:\Temp\restore.tmp\First Storage Group\E00000B4.log' ...
[End] Restoring transaction log - 'First Storage Group'
[Start] Applying transaction log ...
[End] Applying transaction log
[End] Storage Group - 'First Storage Group'
.....
[Start] Storage Group - 'SG2'
[Start] Database - 'acct'
Restoring file 'E:\Program Files\Exchsrvr\SG2\acct.edb' ...
Restoring file 'E:\Program Files\Exchsrvr\SG2\acct.stm' ...
[End] Database - 'acct'
[Start] Restoring transaction log - 'SG2'
Restoring Log File 'F:\Temp\restore.tmp\SG2\E0100072.log' ...
Restoring Log File 'F:\Temp\restore.tmp\SG2\E0100073.log' ...
[End] Restoring transaction log - 'SG2'
[Start] Applying transaction log ...
[End] Applying transaction log
[End] Storage Group - 'SG2'
[End] Exchange Server - 'WIN2000SVR'

E:\Program Files\Vianet Backup Manager\bin>

```

- e. (Example 2) To restore the database named [mail] in storage group [SG5] from backup available in [F:\Backup] to an exchange server named [WIN2000SVR] using the temporary directory [F:\Temp], you can use this command:

E:\Program Files\Vianet Backup Manager\bin> ExchangeRestore DIR="F:\Backup"
TEMP="F:\Temp" SERVER="WIN2000SVR" SERVICE="Microsoft Information Store"
STORAGE="SG5" DATABASE="mail"

```

Exchange Server Recovery Example:

E:\Program Files\Vianet Backup Manager\bin> ExchangeRestore DIR="F:\Backup"
TEMP="F:\Temp" SERVER="WIN2000SVR" SERVICE="Microsoft Information Store"
STORAGE="SG5" DATABASE="mail"

```

```

Microsoft Exchange Server 2000/2003 Backup Recovery Utility

[Start] Storage Group - 'SG5'
[Start] Database - 'mail'
Restoring file 'E:\Program Files\Exchsrvr\SG5\mail.edb' ...
Restoring file 'E:\Program Files\Exchsrvr\SG5\mail.stm' ...
[End] Database - 'mail'
[Start] Restoring transaction log - 'SG5'
Restoring Log File 'F:\Temp\restore.tmp\SG5\E0300012.log' ...
Restoring Log File 'F:\Temp\restore.tmp\SG5\E0300013.log' ...
[End] Restoring transaction log - 'SG5'
[Start] Applying transaction log ...
[End] Applying transaction log
[End] Storage Group - 'SG5'

E:\Program Files\Vianet Backup Manager\bin>

```

- f. Repeat the same procedure for each database to be restored to the Exchange Server.
 - g. You can use [Start] -> [Program] -> [Administrative Tools] -> [Event Viewer] to check if there are any errors generated from the exchange databases restoring activities.
- vi. However, if ExchangeRestore.exe still cannot mount the restored files and returns with strange errors, e.g. bad signature, or null errors, the Exchange server might have incorrectly spooled the backup files in the first place. Please try to mount the restored database and log files manually by the following instructions:
- a. In MS Exchange System Manager, dismount both the Mailbox Store and Public Folder Store from the server.
 - b. Copy all the restored database files to the MDBDATA folder (By default, the MDBDATA folder is located under C:\Program Files\Exchsrvr\)
- Mailbox Store:
- priv1.edb
 - priv1.stm
- Public Folder Store:
- pub1.edb
 - pub1.stm
- c. Run "eseutil /r" to apply the transaction log files to bring the database to a consistent state, e.g.:

```
C:\Program Files\Exchsrvr\MDBDATA> ..\bin\eseutil /r e00
```

The above command will try to bring all the databases handled by the transaction log files starting with "e00" located in "C:\Program Files\Exchsrvr\MDBDATA" into clean shutdown state.
 - d. Run "eseutil /p" to repair the database files, e.g.:

```
C:\Program Files\Exchsrvr\MDBDATA> ..\bin\eseutil /p priv1.edb
C:\Program Files\Exchsrvr\MDBDATA> ..\bin\eseutil /p publ.edb
```
 - e. Mount both Mailbox Store and Public Folder Store to the Server through the MS Exchange System Manager.
- vii. Completed

13 Backup/Restore Windows System State

(Not Available in Lite Client)

This chapter will describe in details how to use Vianet Backup Manager to backup Windows System State and how you can restore your Windows System State from backup.

13.1 Requirements

- i. Microsoft Windows XP Professional / 2003 / Vista
- ii. Vianet Backup Manager must be installed onto the computer containing the system state you want to backup
- iii. Windows system state will be backed up to a temporary file before it is sent to Vianet Online Backup. Please make sure you have sufficient space on your computer to store the temporary file when you run the backup job.

13.2 Overview

Vianet Backup Manager will backup your Microsoft Exchange Server by taking the following steps:

- i. Run all Pre-Commands of this backup set
- ii. Windows System State will be backed up to a temporary directory specified in its backup set
- iii. Run all Post-Commands of this backup set
- iv. Upload the Windows System State backup files from the temporary directory to Vianet Online Backup
- v. Remove the Windows System State temporary backup files from the temporary directory if [Setting] -> [Temporary Directory for storing backup files] is enabled

13.3 How to backup Windows System State

Please follow the instructions below to backup Windows System State using Vianet Backup Manager:

- i. Open Vianet Backup Manager

Right click Vianet Backup Manager icon available in the system tray and choose [Open]

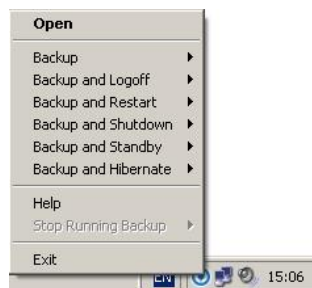

- ii. Create a backup set
 - a. To start setting up backup sets, click the  button to open the [Backup Setting] dialog.

- b. On the left panel, press the  button to create a new backup set.
- c. On the dialog, choose [System State Backup] as the [Type].

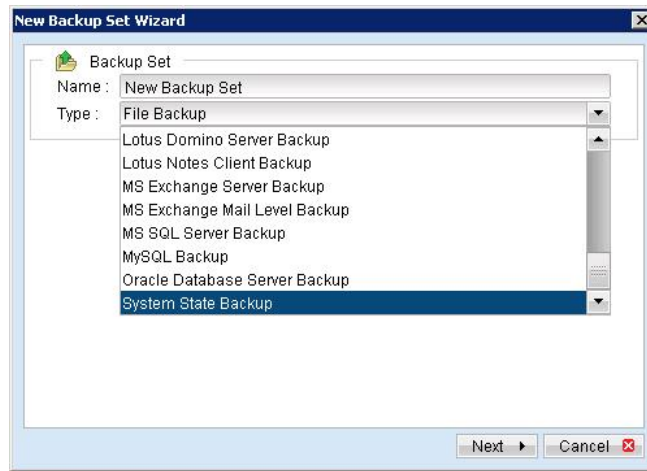

- d. Enter a name for your backup set

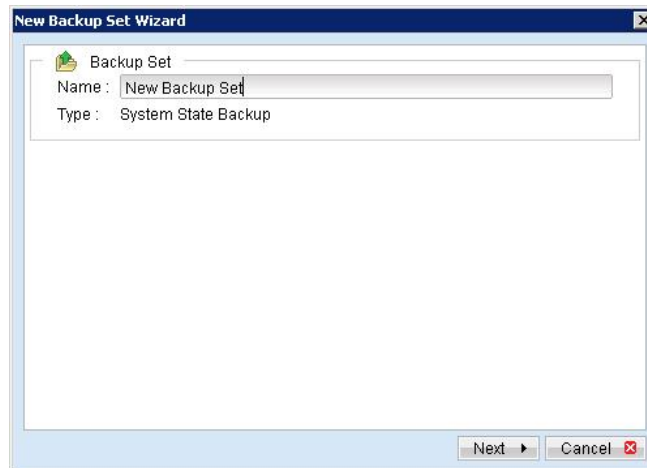

- e. Set the backup schedule for this backup set

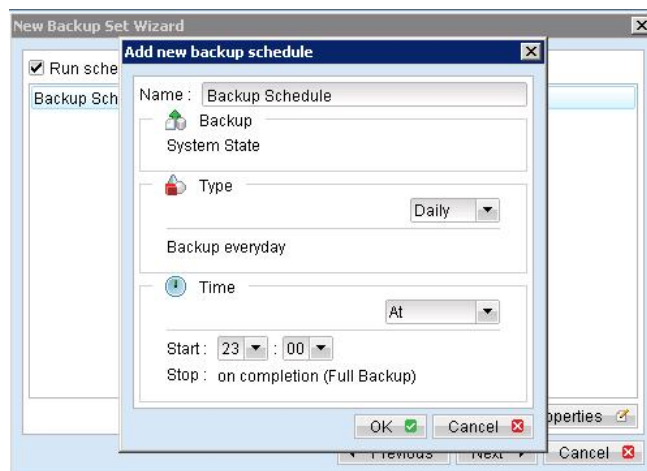

- f. Set the encryption algorithm, encryption mode and encrypting key for this backup set



(Hint: For maximum security, please select AES (Advanced Encryption Standard) Algorithm, CBC (Cipher Block Chaining) mode and use an encrypting key with more than 8 characters.)

iii. Run Backup

- a. Press the [Backup] button on the main page of Vianet Backup Manager dialog.
- b. Select the backup set you want to run and select [Offsite Backup Server] to start backing up your files to Vianet Online Backup. If applicable, you can change the In-File Delta Type also.

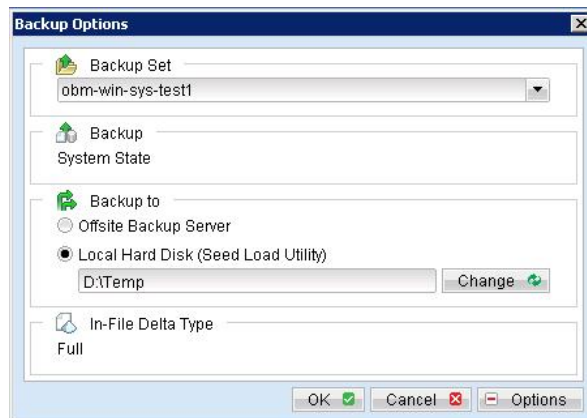

- c. You should get something similar to the screen shot below.

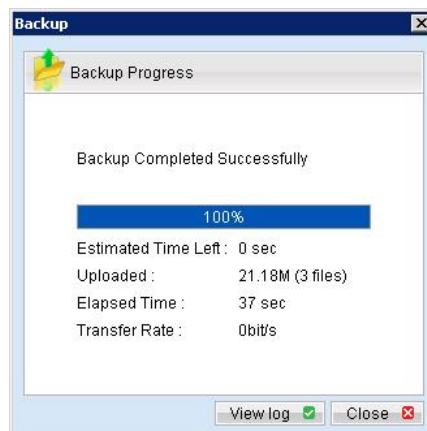

13.4 How to restore Windows System State

Please follow the instructions below to restore Windows System State from Vianet Online Backup.

- i. Install Vianet Backup Manager (if required)

Please refer to the [Installation] section for information on how to install Vianet Backup Manager onto your computer.
- ii. Restore the Windows System State Backup File (i.e. SystemState.bkf) from the backup server
- iii. Use [NTBackup.exe] to restore your Windows System State to its backup time from the backup file by following the instructions below:
 - a. Run [NTBackup.exe] from [Start] -> [Run]
 - b. Press the [Restore Wizard] button and then press the [Next] button
 - c. Press the [Import] button and use the [Browse] button to select the backup file [SystemState.bkf] downloaded
 - d. Select the checkbox next to the description that matches your backup file
 - e. Press the [Next] button and then the [Finish] button
- iv. Completed

14 Backup/Restore Individual Brick Level Backup for Microsoft Exchange Server (Not Available in Lite Client)

14.1 Requirements

- i. Microsoft Exchange Server 2000 with Services Pack 3 and post-SP3 update rollup installed. Please refer to <http://www.microsoft.com/exchange/> for more information.
Or
Microsoft Exchange Server 2003 or Microsoft Exchange Server 2007.
- ii. Vianet Backup Manager must be installed onto the computer running Microsoft Exchange Server 2000 / 2003 / 2007.

14.2 Overview

Brick Level Backup for Microsoft Exchange Server is not designed to fully protect an Exchange server, but to facilitate easy backup and fast restore of individual emails, contacts, calendars, tasks etc. The brick level restore cannot fully recover the Information Store after a disaster. If used, a brick level backup must be utilized in conjunction with full Information Store Backup, in order to fully protect the exchange server.

14.3 Granting Privileges

Brick Level Backup requires "Full Mailbox Access" permission for the user running Vianet Backup Manager. Normally, Vianet Backup Manager can acquire the permission on its own but if you encounter 'Access Denied' errors you need to manually grant access privileges to the user running Vianet Backup Manager using one of the following instructions below:

For one specific mailbox

Use the following procedure to grant access to an Exchange 2000 / 2003 / 2007 mailbox:

- 1 Start Active Directory Users and Computers.
- 2 On the View menu, ensure that the Advanced Features check box is selected.
- 3 Right-click the user whose mailbox you want to give permissions to and choose Properties.
- 4 On the Exchange Advanced tab, click Mailbox Rights.
- 5 Notice that the Domain Admins and Enterprise Admins have both been given Deny access to Full Mailbox access.
- 6 Click Add, click the user or group who you want to have access to this mailbox, and then click OK.
- 7 Be sure that the user or group is selected in the Name box.
- 8 In the Permissions list, click Allow next to Full Mailbox Access, and then click OK.
- 9 Click Ok all the way out.
- 10 Restart the Microsoft Exchange Information Store.

For mailboxes located within a specific mailbox store

Use the following procedure to grant access to an Exchange 2000 / 2003 / 2007 mailbox found on a specific mailbox store:

- 1 Start Exchange System Manager.
- 2 Drill down to your server object within the appropriate Administrative Group. Expand the server object and find the required mailbox store within the appropriate Storage Group. Right-click it and choose Properties.
- 3 In the Properties window go to the Security tab.
- 4 Click Add, click the user or group who you want to have access to the mailboxes, and then click OK.
- 5 Be sure that the user or group is selected in the Name box.
- 6 In the Permissions list, click Allow next to Full Control, and then click OK.
- 7 Click 'Apply' and 'OK'
- 8 Restart the Microsoft Exchange Information Store.

For mailboxes located within a specific server

- 1 Start Exchange System Manager.
- 2 Drill down to your server object within the appropriate Administrative Group. Right-click it and choose Properties.
- 3 In the Properties window go to the Security tab.
- 4 Click Add, click the user or group who you want to have access to the mailboxes, and then click OK.
- 5 Be sure that the user or group is selected in the Name box.
- 6 In the Permissions list, click Allow next to Full Control, and then click OK.
- 7 Click Ok all the way out.
- 8 Restart the Microsoft Exchange Information Store.

14.4 How to backup Individual Brick Level Backup



Please follow the instructions below to backup all individual items within your Microsoft Exchange Server 2000 / 2003 / 2007 using Vianet Backup Manager:

- i. Open Vianet Backup Manager

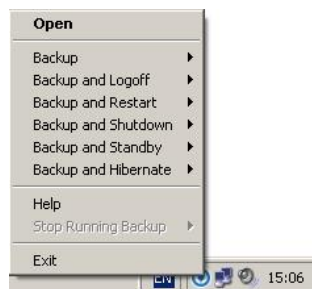
Right click Vianet Backup Manager icon available in the system tray and choose [Open]



ii. Create a backup set

- a. To start setting up backup sets, click the  button to open the [Backup Setting] dialog.
- b. On the left panel, press the  button to create a new backup set.
- c. On the dialog, choose [MS Exchange Mail Level Backup] as the [Type].

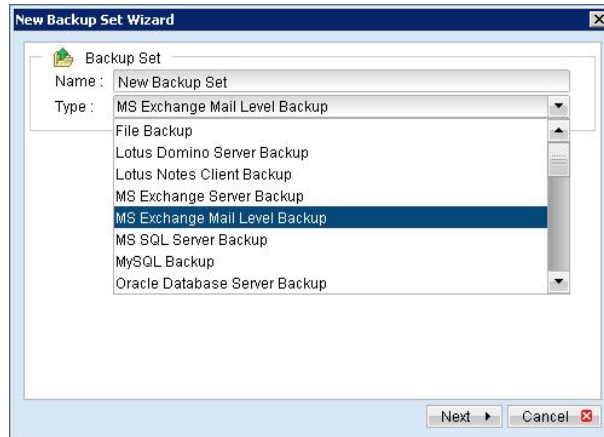

- d. Enter a name for your backup set.



- e. Select the email account(s) to backup.

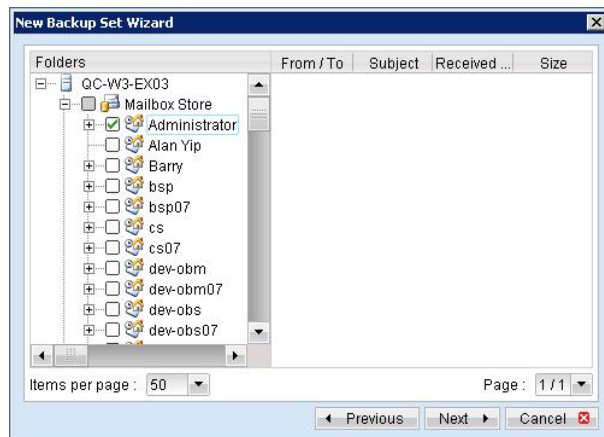

You can drill down to select individual items.

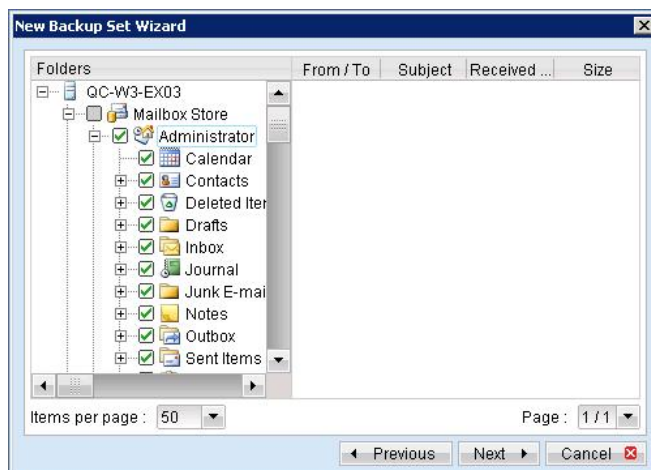

f. Set the backup schedule

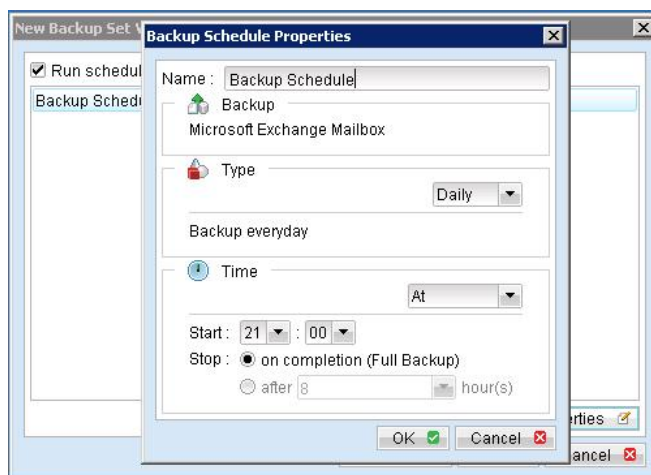
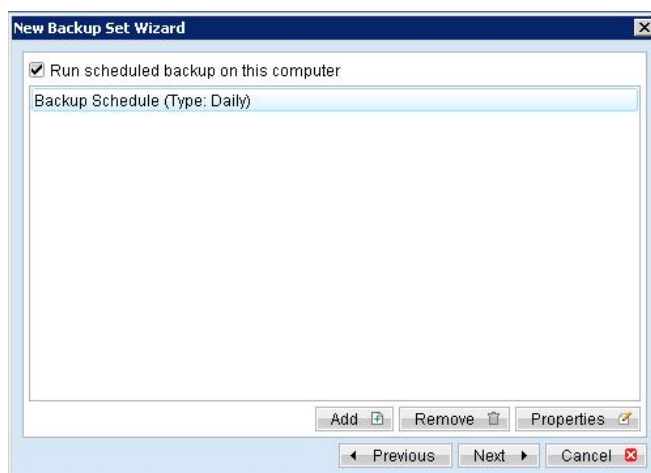

- g. Set the encryption algorithm, encryption mode and encrypting key for this backup set



(Hint: For maximum security, please select AES (Advanced Encryption Standard) Algorithm, CBC (Cipher Block Chaining) mode and use an encrypting key with more than 8 characters.)

- iii. Run Backup

- a. Press the [Backup] button on the main page of Vianet Backup Manager dialog.
- b. Select the backup set you want to run and select [Offsite Backup Server] to start backing up your files to Vianet Online Backup. If applicable, you can change the In-File Delta Type also.

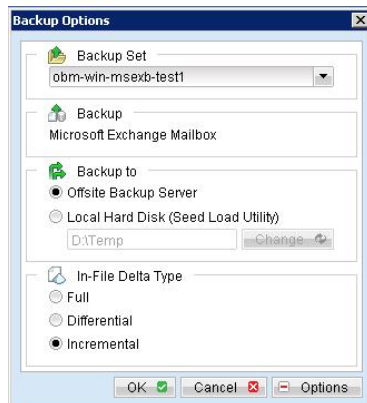

- c. Click [OK] to start backing up your files to Vianet Online Backup.
- d. You should get something similar to the screen shot below.

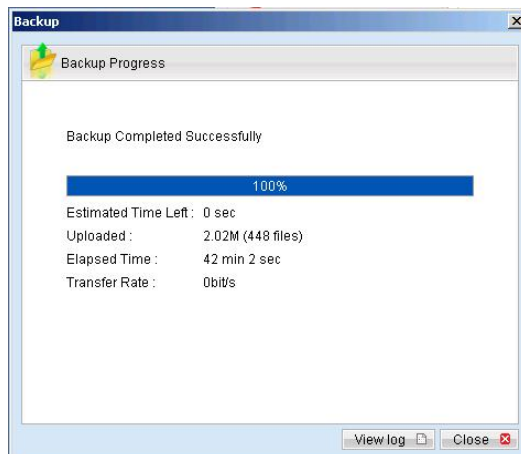

14.5 How to restore Individual Brick Level Backup

Please follow the instructions below to restore individual emails, contacts, calendars, tasks etc. from Vianet Online Backup back into your exchange server. Please note that individual brick level can only be restored using the Vianet Backup Manager client.

- i. Open Vianet Backup Manager

Right click Vianet Backup Manager icon available in the system tray and choose [Open]

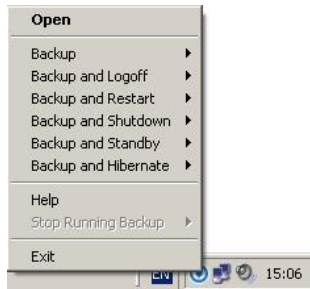

- ii. Open Vianet Backup Manager from the System Tray (see previous sections for details).
- iii. Select the [Restore] button on the left of the main page of Vianet Backup Manager dialog.
- iv. Select the backup set from which you would like files to be restored from the list.
- v. Select the items you want to restore

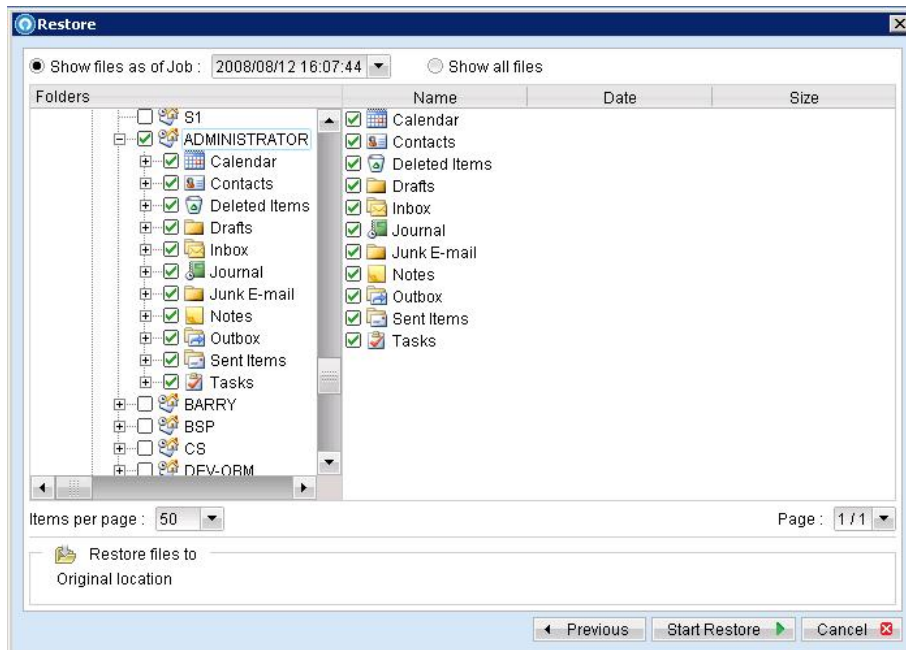

- vi. Press the [Start Restore] button to restore

- vii. Restore complete. Please logon to exchange to get the restored items.

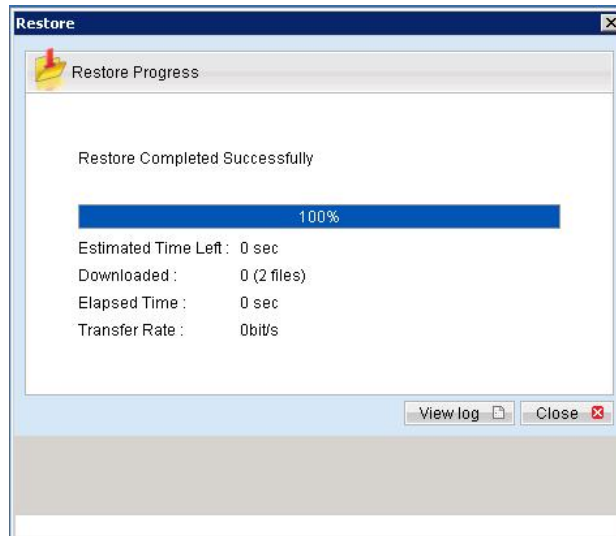

15 Backup/Restore MySQL Server

This chapter will describe in details how to use Vianet Backup Manager to backup your MySQL server and how you can restore your MySQL server from the database backup files.

15.1 Requirements

- i. Vianet Backup Manager must be installed onto the computer running MySQL server.
- ii. Data from MySQL server will be backed up to a temporary directory before they are sent to Vianet Online Backup. Please make sure you have sufficient space on your computer to store these data when you run the backup job.
- iii. There must be a MySQL account can be used to connect from localhost.

Add two new MySQL accounts for Vianet Backup Manager

```
mysql> GRANT ALL PRIVILEGES ON *.* TO 'root'@'localhost'  
-> IDENTIFIED BY 'some_pass';  
mysql> GRANT ALL PRIVILEGES ON *.* TO 'root'@'localhost.localdomain'  
-> IDENTIFIED BY 'some_pass';  
mysql> FLUSH PRIVILEGES;
```

They are superuser accounts with full privileges to do anything with a password of some_pass.

15.2 Overview

Vianet Backup Manager will backup your MySQL server by taking the following steps:

- i. Run all Pre-Commands of this backup set
- ii. All database(s) (either local or external) selected are backed up to a temporary directory specified in its backup set
- iii. Run all Post-Commands of this backup set
- iv. Upload all backup files from the temporary directory to Vianet Online Backup
- v. Remove temporary files from the temporary directory if [Setting] -> [Temporary Directory for storing backup files] is enabled

15.3 How to backup MySQL server on Windows

Please follow the instructions below to backup your MySQL server using Vianet Backup Manager:

- i. Open Vianet Backup Manager

Right click Vianet Backup Manager icon available in the system tray and choose [Open]

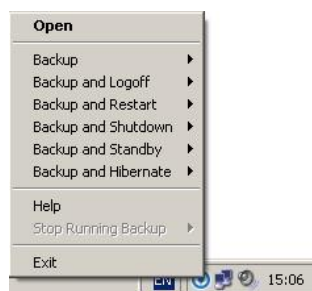

- ii. From the Menu, Choose [Backup Set] -> [New] -> [MySQL Backup Set]
Create a backup set

- a. To start setting up backup sets, click the button to open the [Backup Setting] dialog.
- b. On the left panel, press the button to create a new backup set.
- c. On the dialog, choose [MySQL Backup] as the [Type].

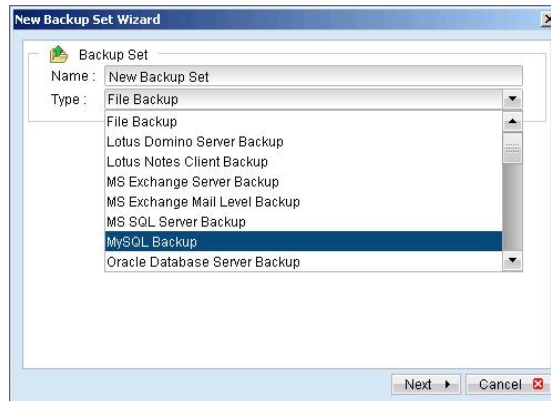

- d. Enter a name for your backup set

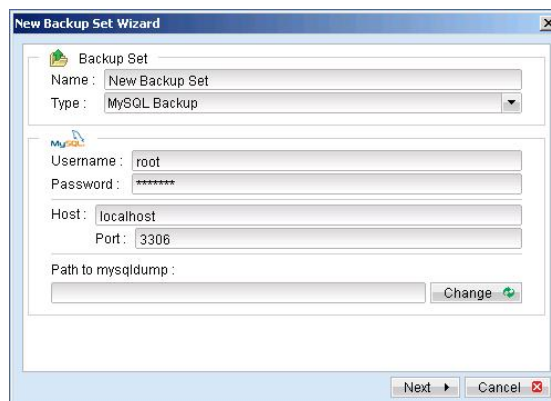

- e. Enter the root password, the MySQL server TCP/IP port number and the path to MySQL backup utility (mysqldump)
- f. Select the database(s) to be backup

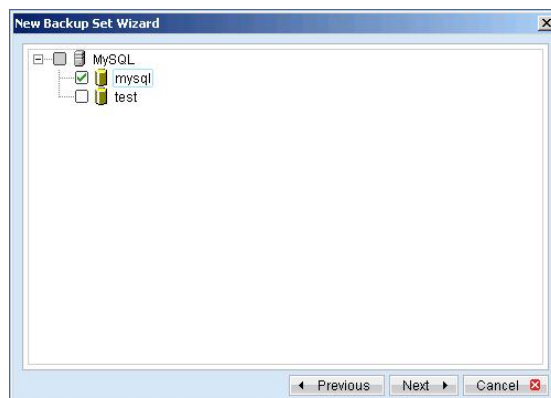

- g. Enter a temporary directory for storing the backup files before they are sent to Vianet Online Backup, e.g. C:\Backup\MySQL

- h. Set the backup schedule for Database Backup

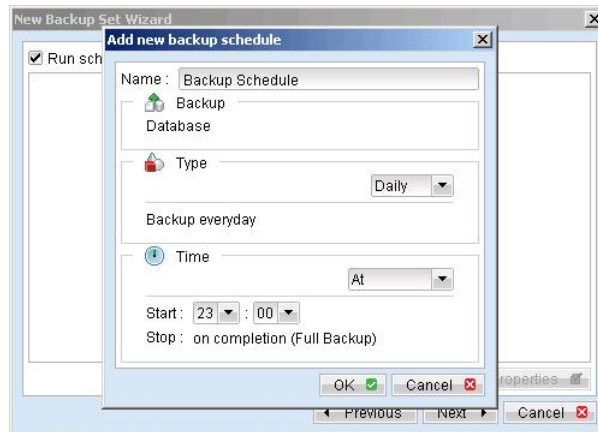

- i. Set the encryption algorithm, encryption mode and encrypting key for this backup set



(Hint: For maximum security, please select AES (Advanced Encryption Standard) Algorithm, CBC (Cipher Block Chaining) mode and use an encrypting key with more than 8 characters.)

- iii. Run Backup

- a. Press the [Backup] button on the main page of Vianet Backup Manager dialog.
- b. Select the backup set you want to run and select [Offsite Backup Server] to start backing up your files to Vianet Online Backup. If applicable, you can change the In-File Delta Type also.

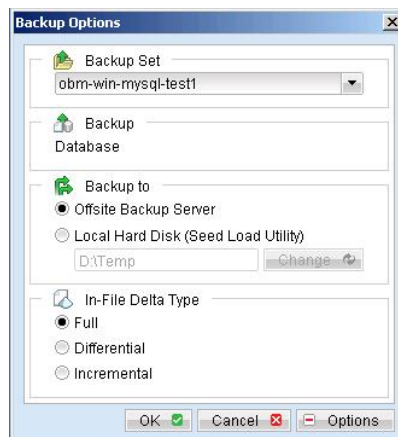

- c. You should get something similar to the screen shot below.

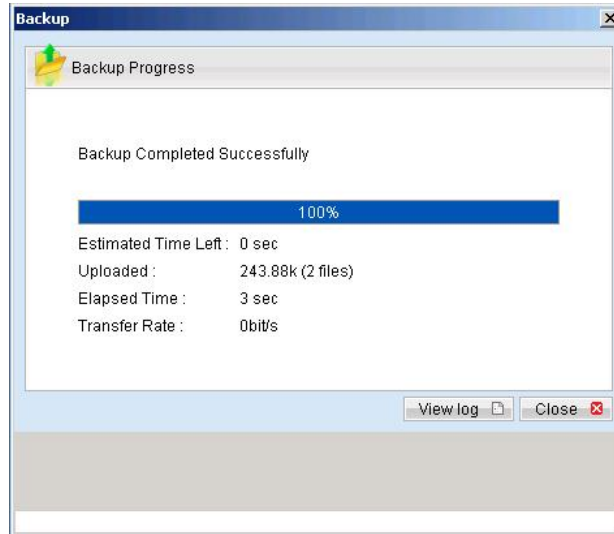

15.4 How to backup MySQL server on Linux (command line mode)

If you want to setup Vianet Backup Manager to backup MySQL server running on Linux using command line mode, please do the followings:

- i. Create a backup account on Vianet Online Backup
- ii. Logon to the web interface of Vianet Online Backup using the backup account created in the previous step (doesn't matter if it is not from the Linux server running the MySQL server to be backed up)
- iii. Create a new backup set by pressing the [Backup Set] -> [Add] button
- iv. Select the [Backup Set] -> [Type] -> [MySQL Database Server] radio button and press the [Update] button (which can be found at the bottom of the page)
- v. Setup all [Backup Set] -> [Database Backup Setting]

Settings	Descriptions
MySQL Username (e.g. root)	A MySQL user account that has backup access to the databases to be backed up (e.g. root). Please refer to the [Requirements] section for details
MySQL Password	Password of the MySQL user account being used
Host	IP address / Hostname of the MySQL Server, e.g. localhost
MySQL Connection TCP/IP Port	TCP/IP port used to access the MySQL Server (default: 3306)
Path to MySQL backup utility (mysqldump)	Full path to where mysqldump can be found (e.g. /usr/bin/mysqldump)
Temporary Spooling Directory	A temporary directory to be used to store all MySQL database dump files before they are uploaded to the backup server
Enable Delete Temp. File	Whether to delete the temporary MySQL database dump files after they are uploaded to the backup server

- vi. Setup the [Backup Set] -> [Backup Source] setting
 - Add an "MySQL" entry to the [Backup Source] if you want to backup all databases under this MySQL Server
 - Add two entries, "MySQL/database1" and "MySQL/database2", to the [Backup Source] if you want to backup both "database1" and "database2" under this MySQL Server

(Please use "\" instead of "/" if the MySQL server to be backed up is running on Windows instead of Linux)
- vii. Setup the [Backup Set] -> [Backup Schedule] by pressing the [Add] link next the "Backup Schedule" sub-title
- viii. Install Vianet Backup Manager onto the Linux server running MySQL server (Please refer to the [\[2.1 Installation of Vianet Backup Manager\]](#) section for details. The command line mode installation instructions are available on the web interface)
- ix. Completed

If you have started up the Vianet Backup Manager backup scheduler in the previous step, selected databases will be backed up automatically at scheduled time

15.5 How to restore MySQL server

Please follow the instructions below to restore MySQL server from Vianet Online Backup.

- i. Download the database backup files to be restored from Vianet Online Backup

Please refer to the [\[5.3 Restoring file\]](#) section for information on how to download backup files from Vianet Online Backup.
- ii. Restore the database named [db_name] from the database backup file [db_name.sql]:
 - a. Connect to the MySQL server

(Windows) C:\> mysql
(Linux) [root@server ~]# mysql
 - b. Create the database to be restored

mysql> CREATE DATABASE IF NOT EXISTS db_name
 - c. Restore the database backup file back into the MySQL server

mysql> use db_name ;
mysql> source db_name.sql ;

If db_name.sql is not located in the current directory, please specify the full path to the db_name.sql file in the command above.
- iii. Repeat the same procedure for each database to be restored to the MySQL Server.
- iv. Completed

16 Email Reporting

Vianet Online Backup makes use of an email system to keep you informed about the status of your backup activities. Please make sure your email address is up to date in order to receive these reports. (Email address updates can be sent to backup@vianet.ca. Please provide your current backup username or Customer ID.)

Users will receive the following reports:

Inactive Accounts

You will receive an inactive user reminder in email if your account has been left inactive for the period of 7 days.

Off-line Backup Reminder

Sends a reminder to users who have missed their off-line backup jobs.

17 Web Features

Note: Access to Web Features is available [upon request](#).

Other than the features of Vianet Online Backup Manager described in the previous chapter, the web interface provides you access to some additional features. This chapter describes each of these features in details.

17.1 Restore/Delete/Undelete Backup Files

Using the [File Explorer], you can browse through the backup data (both current and previous versions). You can select any current backup files to Restore or Delete. You can also select any deleted backup files (in gray) to Undelete.

17.2 Review Backup Jobs

To review a backup job, select the required backup job from the [Backup Set] and [Backup Job] drop down lists.

Key	Description
Job Status	The overall status of the backup job. Normally, you should see "Backup finished successfully" in this field. If you happen to get something else, please click the [Detailed Report] images on the page.
Backup Time	The time when the backup job ran
New Files	Total number and size of backup files added to your backup set
Updated Files	Total number and size of backup files updated in your backup set
Deleted Files	Total number and size of backup files deleted from your backup set
Moved Files	Total number and size of backup files relocated in your backup set
Backup Data Size	The total backup data stored in the data area
Retention Area Size	The total backup data stored in the retention area. Old copies of updated or deleted backup files are retained in the retention area for the number of days as specified by the retention policy of the backup set before they are removed from the system.
Total Upload	Total number and size of backup files uploaded to the backup server
Backup Quota	Backup Quota
Remaining Quota	Remaining Quota

You can open the [Full Backup Report] to review all information logged by a backup job by clicking the [Detailed Report] image on the [Report] panel.

Full Backup Report			
Full Backup Report		Generated at: Tue Aug 12 18:31:05 CST 2008	
Backup Job Summary		Backup Job Statistics	
Login Name	NewAccount	New Files*	4 [8.4M / 8.8M (5%)]
Backup Set	New Backup Set (1218536810931)	Updated Files*	0 [0 / 0 (0%)]
Backup Job	2008-08-12 (18:27)	Permission Updated Files*	0 [0 / 0 (0%)]
Job Status	Backup finished successfully	Deleted Files*	0 [0 / 0 (0%)]
Backup Time	2008/08/12 18:27 - 2008/08/12 18:27 (CST)	Moved Files*	0 [0 / 0 (0%)]
* Unit = No of files [Total file zipped size / Total file size (ratio)]			
Backup Logs			
No.	Type	Timestamp	Backup Logs
1	Info	2008/08/12 18:27	Start [Windows XP (WINDOWS-USER), AhsayOBM 5.5.1.0]
2	Info	2008/08/12 18:27	Start running pre-commands
3	Info	2008/08/12 18:27	Finished running pre-commands
4	Info	2008/08/12 18:27	Start running post-commands
5	Info	2008/08/12 18:27	Finished running post-commands
New Files			
No.	Dirs / Files	Zipped / Size [Ratio]	Last Modified
1	C:\	1.5k / 0 [0%]	-
2	C:\test	1.5k / 0 [0%]	-
3	C:\test\test.mp3	8.4M / 8.8M [5%]	2008/07/17 10:12
4	C:\test\test.txt	5k / 3.4k [0%]	2008/06/23 18:33
Updated Files			
No.	Files	Zipped / Size [Ratio]	Last Modified
No files have been updated.			
Permission Updated Files			
No.	Dirs / Files	Zipped / Size [Ratio]	Last Modified
No Permissions have been updated.			
Deleted Files			
No.	Dirs / Files	Zipped / Size [Ratio]	Last Modified
No files have been deleted.			
Moved Files			
No.	Files	Zipped / Size [Ratio]	Last Modified
No files have been moved.			

Parameter	Description
Backup Set	The name of the backup set
Backup Job	The name of the backup job (which is the start time of the backup job)
Backup Status	The overall status of the backup job.
Backup Time	The time when the backup job ran
Backup Log	All messages logged when running this backup job
New Files	Total number and size of backup files added to your backup set
Updated Files	Total number and size of backup files updated in your backup set
Deleted Files	Total number and size of backup files deleted from your backup set
Moved Files	Total number and size of backup files relocated in your backup set
New File List	Full list of all backup files added to your backup set
Updated File List	Full list of all backup files updated in your backup set
Deleted File List	Full list of all backup files deleted from your backup set
Moved File List	Full list of all backup files relocated in your backup set

17.3 Review Storage Statistics

You can review the amount of data you have stored on the backup server and uploaded to the backup server on each day by opening the [Statistics] panel available on the web interface. To review your storage statistics for a different month, just select the month you are after by selecting from the [Month] drop down list.

Key	Description
Date	The date the following statistics are collected
Data Area	Total number and size of backup files stored in the data area on a particular date
Retention Area	Total number and size of backup files stored in the retention area on a particular date
Uploaded Size	Total number and size of backup files uploaded to the backup server on a particular date
Total Storage	Total number and size of backup files stored under your backup account on a particular date